

2019 Catalog



Innovative Operative Solutions for Patient Positioning



Enhancing outcomes for patients and their caregivers:



We Enhance Outcomes For Patients And Their Caregivers

Hill-Rom[®]

Enhancing outcomes for patients and their caregivers[®].

Allen[®]

Innovative operative solutions for patient positioning.

Aspen
Surgical[®]

Enhancing patient and caregiver safety in the operating room.

Trumpf
Medical[™]

Innovative solutions for enhanced safety and optimized workflow in the operating room.

WelchAllyn[®]

Smarter tools to assess, diagnose and treat patients with confidence.

Liko[®]

Protecting patients while mobilizing earlier and often.



In the operating room, we partner with you to provide safer and more efficient surgical care.

 **Safety**

Patient and staff safety go together in the OR. Hill-Rom products are designed to help prevent:

- Pressure-related injuries in the OR
- Ergonomic injuries
- Sharps injuries
- Wrong-site surgery



The percentage of hospital-acquired pressure ulcers that occur in surgical patients.¹

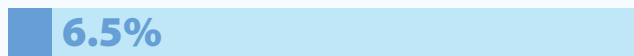

The increase in sharps injury rates in surgical settings since 2000.²



The approximate number of wrong site errors that occur per week in surgery in the US.³



✓ Efficiency



The average hospital's revenue generated in the operating room.⁴



The total hospital costs from the operating room.⁴

Hill-Rom provides a convergence of surgical technologies that provide efficient and safe OR utilization:

- Increase flexibility in scheduling and efficient turnover
- Treat an expanded population through multiple product configurations and bariatric offerings
- Perform procedures of different types and complexity

1. <https://www.o-wm.com/content/intraoperatively-acquired-pressure-ulcers-are-there-common-risk-factors>
2. J Jagger et al. (2011) Increase in Sharps Injuries in Surgical Settings Versus Nonsurgical Settings After Passage of National Needlestick Legislation. AORN Journal.
3. Boodman S. (2011) The Pain of Wrong Site Surgery. The Washington Post.
4. https://www.openanesthesia.org/or_costs_labor_vs_materials

About Allen Medical

Innovative Operative Solutions for Patient Positioning

As an industry leader in patient positioning, our passion is improving patient outcomes and caregiver safety while enhancing efficiency. Our inspiration comes from providing innovative solutions to address our customers' most pressing needs. We immerse ourselves in our customers' world to better address the needs and the daily challenges of their environment. While developing solutions to address patient positioning challenges, or creating systems to offer safe and effective surgical site access for the surgical team, we are committed to providing products of exceptional value and quality.

Product Ordering Information

What's Included







This row of the table contains the product parts, accessories and components that are shipped with the product at no additional charge.

What's Required

This row of the table contains the product parts, accessories and components that are required to use the product properly. These items are sold separately.

What's Optional

This row of the table contains additional optional products, accessories and components that can be used with the product and are sold separately.

<h3>What's Included</h3>  <p>#A-70801 Allen Bow Frame 1 Included</p>  <p>#A-70821 Crank Arm 1 Included</p>	<h3>Product Use Information</h3>
<h3>What's Required</h3> <p><i>Choose One</i></p>  <p>#A-70810C Bow Frame Skin Care Covers Case of 6 Sets</p>  <p>#A-70810 Bow Frame Skin Care Covers Kit Case of 6 Sets</p>	<h3>Product #</h3> <p>This field contains the product # of the Allen product. This number is required when ordering or re-ordering a product.</p>
<h3>What's Optional</h3>  <p>#A-70820 Replacement Pad Set</p>  <p>#A-70825 Foam Head Block Stand</p>	<h3>Product Name</h3> <p>This field contains the name of the Allen product.</p> <h3>Quantity</h3> <p>This field specifies the number of units required to operate a product, or the number of products shipped per container or case.</p>

Products Are Not Made With Natural Rubber Latex

Table Of Contents

8 Spine

13	Allen® Advance Table	31	Wingset Body Positioners
18	Advance Table H-Brackets: Pin & Pinless Options	33	Allen® Bow® Frame
20	Advance Table L2P™ Platform	35	Allen® 4-Post System
27	Allen® Spine System	37	C-Flex® Head Positioning System
29	Spine System Lateral Package	39	C-Flex® AP-Vantage System

49 Gynecology / Urology / Laparoscopy

53	Ultrafins® Stirrups	61	Allen® Hug-U-Vac® Steep Trend Positioners
55	Yellofins® Stirrups	63	Easy Catcher® Disposable System
57	PAL Pro® Stirrups	64	Uro Catcher® System
59	Junior PAL® & Little PAL® Pediatric Stirrups	65	Allen® Easy Irrigation Tower
		66	Knee Crutch

68 Orthopaedics

69	Allen® Lift-Assist® Beach Chair	85	Allen® Traction Boot
73	Universal™ Head Positioner	86	Knee
75	Allen® Arm Positioner	87	Leg
83	Allen® Hug-U-Vac® Lateral Positioner	91	Wrist & Hand

97 General Accessories

99	Patient Transfer	106	Armboards & Arm Positioners
100	Clamps	112	Bariatric Patient
104	Carts & Storage		

114 OR Table Pads / Surfaces / Gel Positioners

118	Astrus Elite™ Surface	122	Armboard Pads
118	Standard & Deluxe Surfaces	124	Gel Positioners
129	Product Index (Alphabetical)	133	Product Index (By Part Number)

Order Information

United States

Toll-free (800) 433-5774
Phone (978) 266-4200
Fax (978) 263-8846
allenmedicalorders@hill-rom.com

Outside US

Sales +1 978 266 4256
Cust. Service +1 978 266 4286
Fax +1 978 266 4426
alleninternationalorders@hill-rom.com

Advance Table Tech Support (978) 266-4245

Please be prepared to provide the product serial number to the support person.

For International Technical Support, please contact your local Allen distributor.

Allen Medical, 100 Discovery Way, Acton, MA 01720

www.allenmedical.com



Allen Spine

Spine Surgery Patient Positioning Systems, Backward Compatible, Future-Proofed & Unique



Uniquely Featured Premium Solutions

Allen® Advance Table *See page 13*

Allen's premium solution for complex spine surgical procedures. Designed with safety and maximum OR efficiency in mind, the Allen Advance Table offers pin or pinless options (*See page 18*) for the attachment of the patient platforms. Convenience features include a modern and intuitive user interface, central locking casters and a multi-control pendant. In addition, the Advance Table pin version can be used in conjunction with our new Lateral to Prone (L2P™) Platform (*See page 20*), which allows for simple and convenient repositioning of the patient from the Lateral to the Prone position without the need to move the patient to a new table.

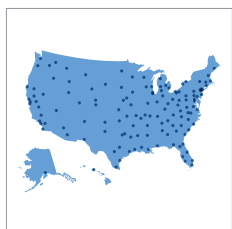

Service You Can Count On

A Company You Can Trust... *See page 22*

Let us take care of your Allen® Advance Table with our nationwide network of service centers. As a company, we understand that our role is to provide services and equipment that are flexible enough to meet the needs of your patients, while assisting you in controlling and reducing cost.

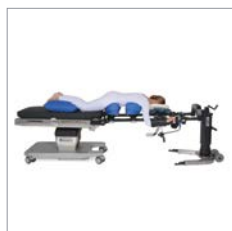

Table Extensions

Allen Spine System *See page 27*

An innovative OR table extension that turns your standard OR table into a table capable of positioning patients for complex spine surgical procedures at a fraction of the price of a stand-alone spine table. It also offers the added advantage of saving space, storing in less than 6 sq ft (0.5 sq m).



Table Top Attachments

See pages 33 - 39

Allen offers innovative table attachments for spine surgery that are compatible with standard OR tables, Allen Advance Table, Allen Flex Frame, or Mizuho OSI Modular Table System*.

*Compatible with rails that are 1.25" (3.2 cm) wide x 1.5" (3.8 cm) tall with a 14.5" (36.8 cm) space between.

Premium Solutions: Unique, Backward Compatible and Future-Proofed



Unique Features: One Base, Multiple Options

180° Patient Rotation



90° Patient Rotation



One Base: Pinned and/or Pinless

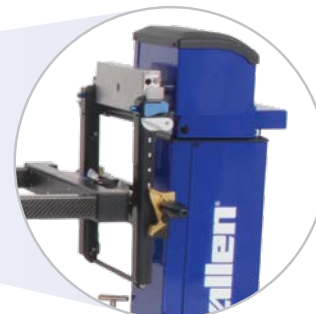



Highly Compatible: Maximizing Investments

Compatible with Allen Advance Table tops, and specified Mizuho OSI tops*



#A-71701
Advance Lateral Top



#A-71400
Advance Rail Top
(with accessories)



#A-71410
Advance Flat Top

*5840-831 OSI Spinal Surgery Table Top - Prone/Rail Top (1997 – April 2015), 5840-726 OSI Imaging Top w/Tempur-Med® Pad - Supine/Flat (1997 – April 2015)



Service You Can Trust: Over 1,000 Certified Technicians

Your Allen Advance Table Supported by the Experienced Hill-Rom Service Team

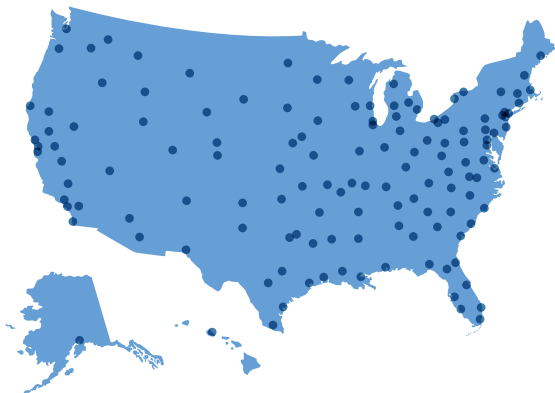

- ✓ On-site Repairs
- ✓ Over 140 Service Centers Nationwide
- ✓ Over 1,000 certified technicians
- ✓ Technical Support Line dedicated to Allen Advance Table
- ✓ Detailed service manual sent with every table
- ✓ Immediate response
- ✓ 1,000,000+ product deliveries and removals performed annually

See page 22 for more information on service.

Upon realizing that we had a problem moving our Allen Advance Table, we contacted our local Allen Sales Rep. He noticed that the table wouldn't roll due to a broken or stuck caster. He was unable to move the table as well so he immediately called Allen Medical. Allen in turn contacted Hill-Rom Service to set up a service call. A Hill-Rom Service Tech was on-site in a day and repaired what happened to be a broken caster. We were very pleased with the service provided by our Sales Rep, Allen Medical and Hill-Rom Service.

- Dave K. | BioMed Tech
Scripps Memorial Hospital, Encinitas, CA

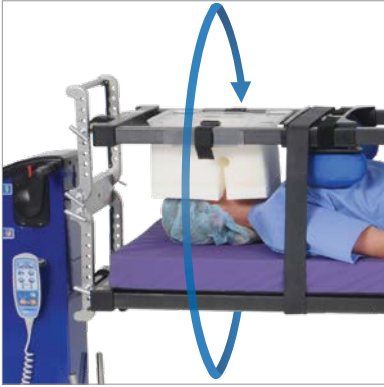

180° and 90° Rotation Capabilities



Modern Intuitive User Interface



EZ-Roll, Centrally Locking Casters



Safety
Designed In...

Allen® Advance Table



A Premium Solution For Complex Spine Surgical Procedures Designed With Improved Safety Features

The Allen Advance Table is designed with a new safety feature to ensure that if the pin that connects the “H-Bracket” to the table base is accidentally pulled out, the patient support top will not fall to the floor. In addition, this solution offers a modern and intuitive user interface with convenience features such as central locking casters — all at a desirable cost.

- Modern user interface helps the user understand the “state” that the table is currently in e.g. locked, unlocked, tilted, trend or reverse trend.
- Central locking casters controlled directly from the pendant.
- EZ-Roll casters help the caregiver when transporting the table around the OR.
- Numbered H-Brackets help with communication between caregivers when attaching the different tops to the base.
- 180° and 90° rotation capabilities.
- Patient weight capacity:
Allen Advance Table: 600 lbs (272 kg)
Advance Table L2P™ Platform: 400 lbs (181 kg)



- Innovative “H-Bracket” design ensures that if the pin connecting the H-Bracket to the table base is accidentally pulled, the patient support top will not fall to the floor.

Advance Table Package #A-71001*

The Advance Table Standard Package includes everything you need for standard prone and supine spine surgical positioning. The package also includes a convenient rolling accessory cart so you can store your tops, rails, supports, etc. all in one place. If you wish to upgrade your table for special positioning needs, we offer a Premium and a Complete Package with additional accessories included. *See page 17*



*Specify Country.

What's Included



#A-71100 (US)*
Advance Table
1 Included



#A-71413**
Advance Pendant
1 Included



#A-71402
Advance H-Bracket
4 Included



#A-71401
Advance Pins
8 Included



#A-71404
Cervical
Traction Bar
1 Included



#A-71411
Advance Safety Straps
4 Included



#A-71410
Advance Flat Top
1 Included



#A-70436
Advance Flat
Top Pad
1 Included



#A-71400
Advance Rail Top
1 Included



#A-71300
Advance Prone
Support Set
1 Included
See page 16



#A-71501†
Adjustable
Accessory Rail
1 Included



#A-71502
Clamp: Adjustable
Accessory Rail
1 Included



#A-71319
Articulating Arm
Support
2 Included



#A-71318
Articulating Arm
Support Clamp
8" (25.4 cm)
2 Included



#A-70501†
Accessory Rail
6" (15.2 cm)
2 Included



#O-RSX2
Large Security Strap
2 Included



#A-71600
Advance
Accessory Cart
1 Included



#A-71405‡
Power Cord
1 Included

What's Optional



#A-70500‡
Armboard Rail



#A-70615-US‡
Advanced Arm Support



#A-71320
Articulating Arm
Support Clamp
10" (25.4 cm)



#A-71314 Standard
#A-71313 Queen
Allen® Advance Pillow



Preventative Maintenance
& Service Contracts
*Available in US Only
See Page 25*

*Alternate part numbers may be used for international versions.
 **Older pendant available, call Customer Service for more information.
 †Specify Rail Type: US, EU, UK, JP, DEN. See product page for international part numbers.
 ‡Specify Country.

Advance Prone Support Set #A-71300

Included With All Advance Table Packages

The Advance Table Prone Support Set is a comprehensive patient support system for the prone position. Although it was developed with the Allen® Advance Table, this prone support system is also compatible with the Allen Flex Frame and the Mizuho OSI Modular Table System*. The hip pads have been developed in several sizes to help accommodate different patient shapes and sizes. In addition, the chest, hip and thigh support pads are constructed using a patented multi-layer foam construction similar to that of the popular Allen Wingsets, which is designed to aid in reducing sheer pressures on the skin.

What's Included



#A-71303
Small Hip
Support With Pad
2 Included



#A-71305
Medium Hip
Support With Pad
2 Included



#A-71307
Large Hip
Support With Pad
2 Included



#A-71309
Left Thigh
Support With Pad
1 Included



#A-71311
Right Thigh
Support With Pad
1 Included



#A-71301
Chest Support
With Pad
1 Included



#A-71316
Head Plate
1 Included



#A-71312
Sling Support
1 Included



#A-70404
Supine Accessory
Top 12" (30.5 cm)
2 Included



#A-70434
Supine Accessory
Top Pad 2" (5 cm)
2 Included



#A-70862
Foam Head Blocks
Case of 6 Sets Included



#A-71262
Medium Ultra
Comfort Covers
Case of 6 Sets Included



#A-71261
Small Ultra
Comfort Covers
Case of 6 Sets



#A-71263
Large Ultra
Comfort Covers
Case of 6 Sets



#A-70863
Foam Arm Supports
Case of 6 Sets

What's Required

What's Optional



#A-70500**
Armboard Rail



#A-70615-US**
Advanced Arm Support



#A-71314
Allen Advance
Pillow - Standard



#A-71313
Allen Advance
Pillow - Queen

*Compatible with rails that are 1.25" (3.2 cm) wide x 1.5" (3.8 cm) tall with a 14.5" (36.8 cm) space between.

**Specify Rail Type: US, EU, UK, JP, DEN. See product page for international part numbers.

Advance Premium Package Upgrade

#A-71002



#A-70700
C-Flex Head Positioning System
1 Included

Upgrade your Advance Table to the Premium Package with the addition of the C-Flex® Head Positioning System.

The C-Flex Head Positioning System can be used in all types of spine surgery including posterior cervical surgery that utilizes skull clamps with pins. The quick-connect coupler makes connecting to a skull clamp easy. Ability to “squeeze and position” supports readjustments intraoperatively. An extensive range of motion makes the C-Flex system ideal for use with extremely kyphotic patients, anterior artificial discs and lateral procedures.

See page 37 for more information on the C-Flex Head Positioning System

Advance Complete Package Upgrade

#A-71003



#A-70700
C-Flex Head Positioning System
1 Included

Upgrade your Advance Table to the Complete Package with the addition of both the C-Flex Head Positioning System and the Allen® Bow® Frame.

The C-Flex Head Positioning System can be used in all types of spine surgery including posterior cervical surgery that utilizes skull clamps with pins. The quick-connect coupler makes connecting to a skull clamp easy. Ability to “squeeze and position” supports readjustments intraoperatively. An extensive range of motion makes the C-Flex system ideal for use with extremely kyphotic patients, anterior artificial discs and lateral procedures.

See page 37 for more information on the C-Flex Head Positioning System



#A-70800
Allen Bow Frame
1 Included

The Bow Frame’s shape creates the desired reverse lordosis needed to open the intervertebral spaces. The Bow Frame enables the patient’s abdomen to hang free during procedures. It is also radiolucent and allows for unrestricted C-arm access. The removable crank is used to adjust the amount of flex and tension in the patient supports.

See page 33 for more information on the Allen Bow Frame

Advance Table H-Brackets: Pin & Pinless Options

Allen now offers pin and pinless options meeting the variation in customer preferences.

Allen® Advance Table With Pin Set-Up

The Advance Standard H-Bracket design ensures that if the pin connecting the H-Bracket to the table base is accidentally pulled, the patient support top will not fall to the floor.



The Advance Standard H-Bracket offers a simple, traditional and intuitive connection system for patient support tops. The innovative connection system ensures that if the pin connecting the H-Bracket to the table base is accidentally pulled, the patient support top will not fall to the floor.

- Numbered H-Brackets help with communication between caregivers when attaching different tops to the base
- Safe & simple pin insertion
- Easily accessible pin storage on column of base



Advance Table Standard H-Bracket #A-71402

What's Optional



#A-71404
Cervical Traction Bar
For use with Pin Set-up



#A-71417
Cervical Traction Device
For use with Pin and
Pinless Set-up

Allen® Advance Table With Pinless Set-Up

The innovative Pinless H-Bracket design maintains the safety offered in our pin design, but eliminates the extra steps of utilizing the cross-pins for securing the patient support top to the Allen Advance Table base.

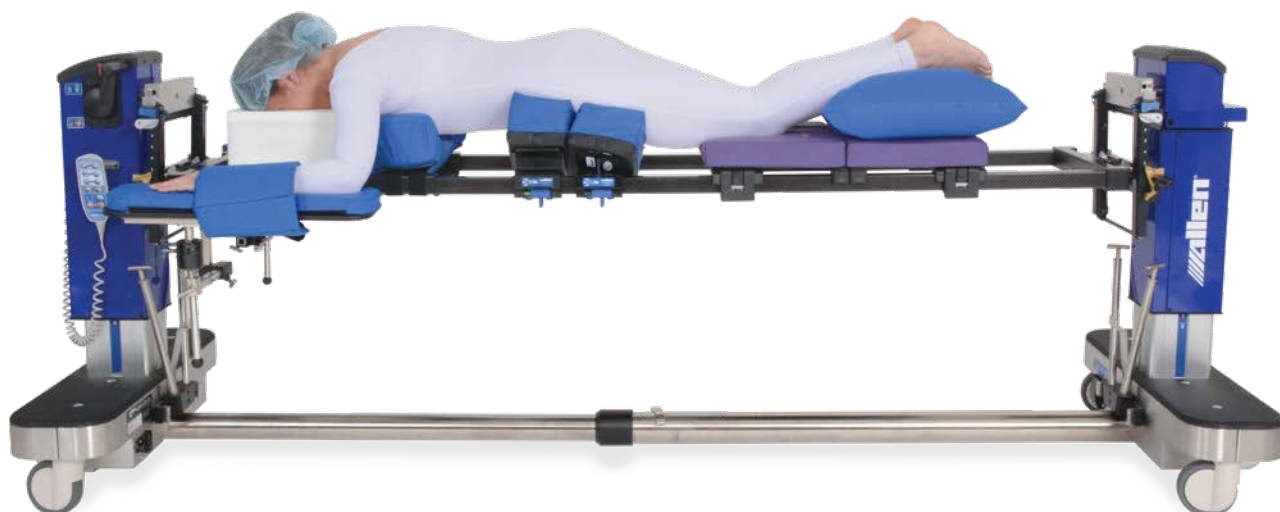

The innovative Advance Pinless H-Bracket option combines safety with an easy to use table-to-base attachment system.

- Secure and controlled movement of the patient
- Attachment of patient support tops to base without the use of cross pins
- Backward compatible with all Allen Advance Tables

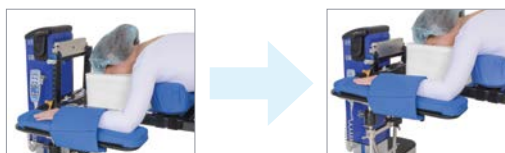

Advance Table Pinless H-Bracket #A-71416 €

Pinless Packages

#A-71414 Set of 4 Pinless H-Brackets & 1 Cervical Traction Device

#A-71415 Set of 2 Pinless H-Brackets & 1 Cervical Traction Device



Cervical Traction Device #A-71417

Not compatible with the Advance Table L2P™ Platform.

Advance Table L2P™ Platform #A-71700 c€

The Advance Table L2P Platform can be used with the Allen® Advance Table* to provide a flexing, lateral surgical patient support platform. The accessories in this set allow a lateral patient to be rotated directly onto the prone supports via the manual rotation capabilities of the Allen Advance Table.*

- Utilize the Allen Advance Table for lateral procedures*
- Create patient flex to open the surgical space
- Single support pad to help reduce shear when flexing
- Integrated air bladder for additional patient flex
- Locks at 90° intervals*
- Works for left or right side lateral approaches
- Eliminates the need to log roll into prone position
- C-arm and O-arm access
- Compatible with standard Advance Rail Top
- Patient Weight Capacity: 400 lbs (181 kg)



*Only compatible with tables with auxiliary power port. For tables without auxiliary power port, please check with your Allen Representative or call Customer Service to confirm compatibility.

What's Included



#A-71701
Advance Lateral Top
1 Included



#A-71703
Advance Lateral Top Pad
1 Included



#A-71706
Advance Lateral Drawsheet
Case of 12 Included



#A-71702-L
Advance Lateral Bracket
2 Included



#A-71702-P
Advance Prone Bracket
2 Included

What's Required



#A-71704
Advance Lateral Air Bladder
1 Included



#A-71706
Advance Lateral Drawsheet
Case of 12

What's Optional



#A-71708-1
Offset Accessory Rail - Left



#A-71708-2
Offset Accessory Rail - Right



#A-71705-US*
Advance Lateral Air Compressor



#A-71709
Air Compressor Tube Set



#A-71600
Advance Accessory Cart



#O-UPBL3S
Lateral Brace 3 Piece Set



#O-ABMT
Multi-Task Armboard



#O-AMA97X1.0S
Clamshell Armboard 1" (2.5 cm) Pad



#O-ABSLT
Easy Armboard With Trigger



#O-AMA96X3.0S
Clamshell Armboard 3" (7.6 cm) Pad



#A-70501-US**
Short Accessory Rail



#A-70502-US**
Long Accessory Rail



#A-40022 (US)**
Easy Lock® Socket



#A-40040 (US)†
Easy Lock® Blade Clamp

*Specify Country: US, EU, UK.

**Specify Rail Type: US, EU, UK, JP, DEN.

†Specify Rail Type: US, EU, UK, JP.

See product page for international part numbers.



Service
You Can Count On...

A Company You Can Trust

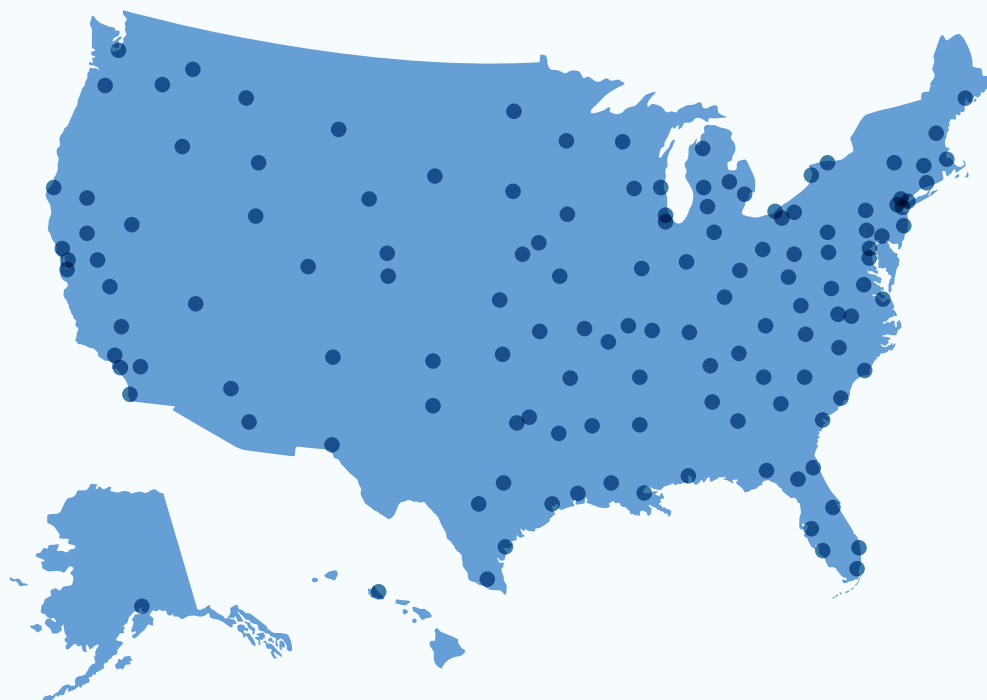

Let Us Take Care Of Your Allen® Advance Table With Our Nationwide Network Of Service Centers

As a company, we understand that our role is to provide services and equipment that are flexible enough to meet the needs of your patients, while assisting you in controlling and reducing cost.



- ✓ On-site Repairs
- ✓ Over 140 Service Centers Nationwide
- ✓ Over 1,000 certified technicians
- ✓ Technical Support Line dedicated to Allen Advance Table
- ✓ Detailed service manual sent with every table
- ✓ Immediate response
- ✓ 1,000,000+ product deliveries and removals performed annually

On-site service/repair is only available for the Allen® Advance Table.
Advance Table service is available in US only.

Care Continuum Services

Delivery Assist

Once your Advance Table arrives at your facility, a trained and certified technician will set up your table to be ready for use at no cost to you.



Immediate Response

With over 140 repair centers nationwide, a service technician is never too far away.



On-Site Repairs

All of our Advance Table repairs are conducted at your facility by one of our trained and certified repair technicians.



On-site service/repair is only available for the Allen® Advance Table.
Advance Table service is available in US only.

Preventative Maintenance & Service Contracts

Allen® Advance Table

Choose Your Preferred Level Of Coverage And Let Us Handle The Rest

	SmartCare™ Protection (A-71SCPROT)	SmartCare Complete (A-71SCC)	SmartCare Prevention (A-71SCPREV)
Compare Coverage Options			
Coverage combined with table purchase at discounted price	✓		
Coverage can be added after table purchase		✓	✓
Access to Hill-Rom certified technicians	✓	✓	✓
Scheduled preventative maintenance	✓	✓	✓
Repair service in 2 business days or less	✓	✓	
On-site repairs	✓	✓	
Parts and labor for repairs: 100% covered	✓	✓	
Parts and labor for repairs: 35% discount			✓

Available in US Only

BEST VALUE

Upon realizing that we had a problem moving our Allen Advance Table, we contacted our local Allen Sales Rep. He noticed that the table wouldn't roll due to a broken or stuck caster. He was unable to move the table as well so he immediately called Allen Medical. Allen in turn contacted Hill-Rom Service to set up a service call. A Hill-Rom Service Tech was on-site in a day and repaired what happened to be a broken caster. We were very pleased with the service provided by our Sales Rep, Allen Medical and Hill-Rom Service.

- Dave K. | BioMed Tech
Scripps Memorial Hospital, Encinitas, CA



With C-Flex® Head Positioner



With C-Prone Head Positioner



Saves Storage Space

Allen® Spine System Components:



- A C-Flex Head Positioner
- B Standard Wingset
- C Flex Frame

- D Flex Frame Armboard Rail
- E Flex Frame OR Table Clamp Set
- F Prone Arm Supports

- G Easy Lock® Socket
- H Supine Top Pads
- I Supine Top Set

Allen® Spine System



An Innovative Table Extension That Turns Your Existing Standard OR Table Into A Spine Table For Complex Spine Surgical Procedures

The Allen Spine System is an extension for your standard OR table that enables you to perform spine surgery with the positioning benefits of a stand-alone spine table such as the Allen Advance Table. In addition, it offers intraoperative lumbar flex and a small storage footprint. The advanced accessories adjust to fit the individual patient's anatomy.

- Intraoperative Flex: Use the power of the table to flex and reposition the patient
- Radiolucent Extension 48" x 17" (1220 mm x 430 mm): Provides excellent C-arm and O-arm access
- Optimized Pressure Management: Chest, hip and head supports
- Versatile: Prone, lateral and supine positioning
- Range of Motion: Provides 20° lateral tilt, trend and flex powered by the OR table
- Height: 25" - 38" (635 mm - 965 mm)
- Fits OR tables with outside rail width 20" - 24" (510 mm - 610 mm)
- Lateral Package available *See page 29*
- Patient Weight Capacity: 500 lbs (227 kg)
- Saves Space: Stores in less than 6 sq ft (0.5 sq m) and accessories can be stored on the frame



Spine System Packages

The Allen® Spine System includes everything below. You also have the choice of an appropriate head positioner based on your surgical needs:

- Choose the C-Flex® Head Positioning System Package #A-70002 if you require an advanced head positioner with simple “squeeze and position” technology that can be used to position the head for all types of spine surgery, including posterior cervical surgeries that require skull clamps and pins.
- Choose the C-Prone Head Positioner Package #A-70000 if you require a standard head positioner that helps position the head quickly and simply for lumbar surgery only.

What's Included



#A-70100
Flex Frame
1 Included



#A-70610
Prone Arm
Supports
2 Included



#A-70400
Supine Top Set
4 Included



#A-70435, #A-70434*
Supine Top Pads
3" (7.6 cm), 2" (5 cm)
4 Included



#A-70200
Standard Wingset System
Chest + Hip
1 Included
See page 31



#A-70260
Comfort Cover Disposables
Case of 5 Sets Included



#A-70310
Comfort Mask Disposables
Case of 5 Included



#A-70510-US**
Flex Frame
OR Table Clamp Set
1 Pair Included



#A-70500-US**
Armboard Rail
2 Included



#A-40022 (US)**
Easy Lock® Socket
2 Included

What's Optional



#A-70501-US**
Short Accessory Rail



#A-70502-US**
Long Accessory Rail



#A-70615-US**
Advanced Arm Support



#O-AMA97X1.0S
Clamshell Armboard
1" (2.5 cm) Pad



#A-70270
Contour™ Breast Positioner

*Specify Thickness.

**Specify Rail Type: US, EU, UK, JP, DEN. See product page for international part numbers.

Complete Your Package

Select A Head Positioner To Complete Your Package Choice

C-Flex® Package: #A-70002



#A-70700
C-Flex Head Positioning System
1 Included

The C-Flex Head Positioning System can be used in all types of spine surgery including posterior cervical surgery that utilizes skull clamps with pins. The quick-connect coupler makes connecting to a skull clamp easy.

See page 37 for more information on the C-Flex Head Positioning System

C-Prone Package: #A-70000



#A-70300
C-Prone Head Positioner
1 Included

The C-Prone Head Positioner allows for vertical and rotational adjustment of the head in the prone position. It includes a fold away mirror and allows for easy airway access.

Spine System Lateral Package #A-70230

Upgrade your Spine System by purchasing the Spine System Lateral Package. It provides intraoperative FLEX for procedures such as XLIF and DLIF.

What's Included



#A-70257
Lateral Hip Pad
1 Included



#A-70501-US*
Short Accessory Rail
1 Included



#A-10029**
Toboggan Gel Pad
15.5" x 10" x .375"
(395 x 245 x 10mm)
1 Pair Included



*Specify Rail Type: US, EU, UK, JP, DEN. See product page for international part numbers.

**#A-10029 Toboggan Gel Pad is not CE.



Optimized

For Pressure Management & Adjustability



Scoliosis



Pediatric Patients

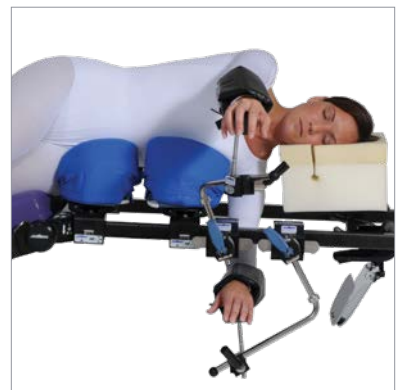

Prone And Lateral Positioning

Wingset Body Positioners #A-70200

Supports That Adjust To Fit The Patient

The wingsets are prone patient supports that have been optimized for pressure management and adjustability. These supports accommodate varying patient anatomies.

- Allows abdomen to hang free
- Designed to reduce compression of brachial plexus
- Offers sternal decompression
- Adjustable for barrel-chested, pediatric and scoliosis patients
- Used with shear-reducing, moisture-absorbent comfort cover disposables
- Multi-layer pad design for optimal pressure management
- Accommodates pediatric to adult patients
- Pads adjust to widths of 10" - 18" (254 mm - 457 mm)
- Fits the Allen® Advance Table
- Fits the Allen Flex Frame
- Fits the Mizuho OSI Modular Table System*
- Patient weight capacity: 500 lbs (227 kg)

Optional Cut-Out Hip Wingset is ideal for larger patients. The Cut-Out Hip Wingset must be used with the Standard Chest Wingset.

What's Included



#A-70200
Standard Wingset System
Hip & Chest
1 Included



#A-70260
Comfort Cover Disposables
Case of 5 Sets Included

What's Optional



#A-70203
Standard Chest Wingset



#A-70204
Chest Wingset With
Radiolucent Screws



#A-70205
Hip Wingset With
Radiolucent Screws



#A-70201
Cut-Out Hip Wingset



#A-70202
Pediatric Wingset System
Hip & Chest



#A-70220
Standard Wingset
Replacement Pads



#A-70221
Pediatric Wingset
Replacement Pads



#A-70270
Contour™ Breast Positioner

*Compatible with rails that are 1.25" (3.2 cm) wide x 1.5" (3.8 cm) tall with a 14.5" (36.8 cm) space between.



Easy To Set-Up



Skin Care Disposables



Storage Cart



Bow® Frame
On OR Table



Bow Frame On
Allen® Advance Table

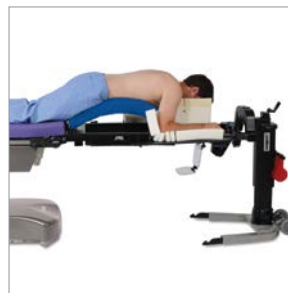

Bow Frame
On Allen Flex Frame



Bow Frame
On Mizuho OSI MTS*

Allen® Bow® Frame #A-70800 €€

Versatile - Compatible with Standard OR Tables, Allen Advance Table, Allen Flex Frame Or Mizuho OSI Modular Table System

The Allen Bow Frame is a platform used to perform less complex spine surgeries. The Bow Frame is more versatile than the existing Wilson™ Frame, as the single device attaches to standard OR tables, Allen Advance Table, Allen Flex Frame and the Mizuho OSI Modular Table System*.

Its shape creates the desired reverse lordosis needed to open the intervertebral spaces. The Bow Frame enables the patient’s abdomen to hang free during procedures. It is also radiolucent and allows for unrestricted C-arm access. The removable crank is used to adjust the amount of flex and tension in the patient supports. Every Bow Frame comes with a storage cart. Ideal for use with Laminectomy, Microdisc procedures, Disc procedures, Fusion procedures, Decompressions, and Foraminotomy.

- Fits standard OR tables
- Radiolucent
- Device weight: 28 lbs (12.7 kg)
- Patient supports are adjustable to fit patients of various sizes
- Patient supports adjust laterally up to 7.5" (19 cm) to relieve pressure on the patient’s abdomen
- Patient weight capacity: 500 lbs (227 kg)
- Lightweight for easy set-up
- Compact for easy storage
- Storage cart included for easy transport
- Skin Care Cover disposables are comprised of cosmetic foam

What’s Included



#A-70801
Allen Bow Frame
1 Included



#A-70821
Crank Arm
1 Included



#A-70815**
Bow Frame Cart
1 Included

What’s Required *Choose One*



#A-70810C
Bow Frame
Skin Care Covers
Case of 6 Sets



#A-70810
Bow Frame
Skin Care Covers Kit
Case of 6 Sets



#A-70805
Bow Frame
Standard Covers Kit
Case of 6 Sets



#A-70862
Allen Foam
Head Block
Case of 6

What’s Optional



#A-70822†
New Replacement Pad Set
Pad Part No.: P008429XASX0



#A-70820†
Old Style Replacement Pad Set
Pad Part No.: P005496XASX0



#A-70825
Foam Head Block Stand

*Compatible with rails that are 1.25" (3.2 cm) wide x 1.5" (3.8 cm) tall with a 14.5" (36.8 cm) space between.

**Specify Rail Type: US, EU, UK, JP. See product page for international part numbers.

†To identify correct replacement pad type, please refer to the pad part number on the underside of the pad.



Easy To Set-Up



Works With Standard Wingsets

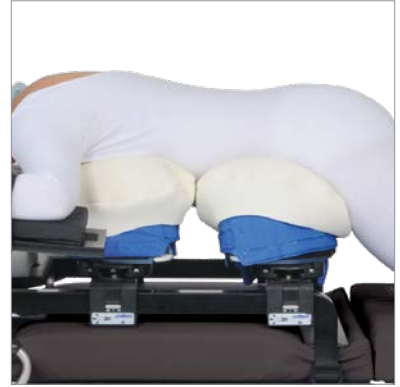

Proven Pressure Management



Allen® 4-Post System #A-71201, #A-71200

Versatile And Easy To Use: Set Up On Your Standard OR Table Within Minutes

The Allen 4-Post System is a lightweight, versatile platform that attaches to a standard OR table via short or long attachment straps and allows the surgeon to place patients in a prone or lateral spine position. Lordosis, kyphosis and a neutral position of the lumbar spine is now achievable without the use of a large and expensive specialty platform. The 4-Post System is designed to allow the patient's abdomen to hang freely, which may help reduce vena caval pressure. This also offers the ability to place an x-ray plate under the patient and provides unrestricted C-arm access.

Ideal for use with Laminectomies, Discectomies, Osteotomies, Fusions, and other prone and lateral procedures.

- Fits standard OR tables
- Radiolucent
- Weighs under 10 lbs (4.5 kg) without the Wingsets
- Patient weight capacity: 227 kg (500 lbs)
- Skin Care Cover disposable made of cosmetic foam
- Compact for storage
- Lightweight and easy to set-up
- Easy to adjust for different size patients

Package Options *Choose One*

#A-71201
Low Height Package



#A-70202
Pediatric Wingset System
Hip & Chest
1 Included

#A-71200
Standard Height Package



#A-70200
Standard Wingset System
Hip & Chest
1 Included

What's Included



#A-70207
Allen 4-Post System Frame
1 Included + 4 Short Straps



#A-70260
Comfort Cover Disposables
Case of 5 Sets Included



#A-70208
Long Attachment Straps
2 Included



#A-70825
Foam Head Block Stand
1 Required



#A-70862
Allen Foam Head Block
Case of 6

What's Optional



#A-70209
Replacement Short
Attachment Straps



#A-70221
Pediatric Wingset
Replacement Pads



#A-70220
Standard Wingset
Replacement Pads



#O-PRSLH
Medium Security
Strap



#A-70615*
Advanced Arm Support



#A-70500*
Armboard Rail

*Specify Rail Type: US, EU, UK, JP, DEN. See product page for international part numbers.



Just Squeeze And Position



Anterior Access



Kyphotic Patients

Precision Adjustments



C-Flex® Head Positioning System #A-70700 CE

Makes Head Adjustments Easy... Just Squeeze And Position

The modular system can be used to position the head during spine surgery. The quick-connect coupler makes connecting to a skull clamp easy. Ability to “squeeze and position” supports readjustments intraoperatively. An extensive range of motion makes the C-Flex system ideal for use with extremely kyphotic patients, anterior artificial discs and lateral procedures.

- Cervical flexion / extension
- Lumbar positioning
- Adjust vertically for kyphotic patients
- Lateral positioning
- Device weight: 20 lbs (9 kg)
- 6" (15.2 cm) lateral adjustment range
- 28" (71 cm) height adjustment range
- 9" (23 cm) extension adjustment range
- +/- 15° lateral tilt
- Works with Standard and Radiolucent Skull Clamps and Headrest Systems from DORO® and Mayfield®*
- Includes fold-away mirror
- Easy airway access
- Fits the Allen® Advance Table
- Fits the Allen Flex Frame
- Fits the Mizuho OSI Modular Table System**
- Patient weight capacity: 500 lbs (227 kg)

What's Included



#A-70701
C-Flex Head Positioning System Base Unit
1 Included



#A-70310
Comfort Mask Disposables
Case of 5 Included



#A-70702
C-Flex Clean Cape Disposables
Case of 10 Included



#A-70710
Starburst Adaptor for Standard Mayfield or DORO*
1 Included



#A-70715
Prone Mask Head Module
1 Included

What's Optional



#A-70720
Flat Plate Head Module
1 Included



#A-70725
Reverse Starburst Adaptor for Standard Mayfield or DORO*



#A-70730
Starburst Adaptor for Radiolucent Mayfield*



#A-70735
Reverse Starburst Adaptor for Radiolucent Mayfield*



#A-70740
Starburst Adaptor for Radiolucent DORO*



#A-70745
Reverse Starburst Adaptor for Radiolucent DORO*



#A-70750
45° Standard Starburst for Radiolucent Mayfield*



#A-70755
45° Standard Starburst for Radiolucent Doro*

*Compatible with Mayfield & Doro Standard Skull Clamps, Mayfield Horseshoe Headrest (with Mayfield Conversion Adaptor) and Doro Horseshoe Headrest with a 3/8-16 UNC thread and a 40 tooth hirth joint. Compatible with Radiolucent Mayfield Skull Clamps with a 1/2-13 UNC thread and a 40 tooth hirth joint. Compatible with Radiolucent Doro Skull Clamps with a M16 x 2 thread and a 40 tooth hirth joint.

**Compatible with rails that are 1.25" (3.2 cm) wide x 1.5" (3.8 cm) tall with a 14.5" (36.8 cm) space between.



Artifact-Free Zone



Odontoid Screw



Optional Leg



Artifact-free
Imaging

C-Flex® AP-Vantage System #A-70110, #A-70111

Advanced Table Imaging Capabilities For Your OR Table

The unique product design eliminates obstructions, leaving nothing but the patient in the shot. C-Flex AP-Vantage System provides for high quality cervical images on an OR table.

The system can be used for both anterior and posterior cervical surgeries; it includes an OR table adaptor (with carbon fiber rails) and the C-Flex head positioning system. All the benefits of the C-Flex system for the OR table with a variety of different head attachments.

Ideal for surgical procedures requiring Odontoid Screws, Cervical Fusion or Artificial Cervical Discs.

- Artifact-Free Imaging
- Squeeze and Position with C-Flex
- Easy Precision Adjustments Intraoperatively
- Added Stability with Optional Leg
- Device Weight: 20 lbs (9 kg)
- Works with Standard and Radiolucent Skull Clamps and Horseshoe Headrest from DORO® and Mayfield®*
- Fits OR Tables with Outside Rail Width 20" - 25.5" (508 mm - 648 mm)
- Fits Most Accessory Rail Types (US, EU, UK, Denyer and Japanese)
- Patient Weight Capacity: 500 lbs (227 kg)

Package Options *Choose One*

#A-70110

Includes C-Flex Head Positioning System



#A-70700
C-Flex Head Positioning System
1 Included

#A-70111

Does Not Include C-Flex Head Positioning System

What's Included



#A-70115
C-Flex AP-Vantage
OR Table Adaptor
1 Included



#A-70118
C-Flex 45°
Starburst Adaptor
1 Included



#A-70117
C-Flex Traction Bar
1 Included



#A-70116
C-Flex AP-Vantage Leg
1 Included

What's Optional



#A-70702
C-Flex Clean Cape Disposables
Case of 10



#A-70750
45° Standard Starburst for
Radiolucent Mayfield*



#A-70755
45° Standard Starburst for
Radiolucent Doro*

*Compatible with Mayfield & Doro Standard Skull Clamps, Mayfield Horseshoe Headrest (with Mayfield Conversion Adaptor) and Doro Horseshoe Headrest with a 3/8-16 UNC thread and a 40 tooth hirth joint. Compatible with Radiolucent Mayfield Skull Clamps with a 1/2-13 UNC thread and a 40 tooth hirth joint. Compatible with Radiolucent Doro Skull Clamps with a M16 x 2 thread and a 40 tooth hirth joint.



Armboard Rail #A-70500

Quick connect mount for attaching arm supports to a spine frame. Compatible with the Allen® Advance Table, Allen Flex Frame and the Mizuho OSI Modular Table System*. Length of rail is 6" (15.2 cm). Patient Weight Capacity: 500 lbs (227 kg).

Specify Rail Type

US #A-70500
EU #A-70500-EU
UK #A-70500-UK

Japan #A-70500-JP
Denyer #A-70500-DEN



Short Accessory Rail #A-70501

Mount accessory rail anywhere on the carbon fiber frame. Rigid mount for attaching any standard rail accessory to a spine frame. Ideal for retractors and arm supports. Compatible with the Allen Advance Table, Allen Flex Frame and the Mizuho OSI Modular Table System*. Length of rail is 6" (15.2 cm). Patient Weight Capacity: 500 lbs (227 kg).

Specify Rail Type

US #A-70501
EU #A-70501-EU
UK #A-70501-UK

Japan #A-70501-JP
Denyer #A-70501-DEN

*Compatible with rails that are 1.25" (3.2 cm) wide x 1.5" (3.8 cm) tall with a 14.5" (36.8 cm) space between.



Long Accessory Rail #A-70502

Mount accessory rail anywhere on the carbon fiber frame. Double-length mount for attaching multiple accessories to a spine frame. Compatible with the Allen® Advance Table, Allen Flex Frame and the Mizuho OSI Modular Table System*. Length of rail is 17" (43.2 cm). Patient Weight Capacity: 500 lbs (227 kg).

Specify Rail Type

US	#A-70502	Japan	#A-70502-JP
EU	#A-70502-EU	Denyer	#A-70502-DEN
UK	#A-70502-UK		



Adjustable Accessory Rail & Clamp

#A-71501, #A-71502

Mount accessory rail anywhere on the carbon fiber frame. Not to be used with arm supports or other accessories. Compatible with the Allen Advance Table, Allen Flex Frame and the Mizuho OSI Modular Table System*. Length of rail is 6" (15.2 cm). Retractor Weight Capacity: 15.5 lb (7 kg)

Shown with both Clamp (#A-71502) & Rail (#A-71501)

What's Included



#A-71502
Clamp for Adjustable
Accessory Rail
1 Included



#A-71501-US*
Adjustable Accessory Rail
Length of rail is 6" (15.2 cm)
1 Included

*Specify Rail Type

US	#A-71501-US
EU	#A-71501-EU
UK	#A-71501-UK
Japan	#A-71501-JP
Denyer	#A-71501-DEN

*Compatible with rails that are 1.25" (3.2 cm) wide x 1.5" (3.8 cm) tall with a 14.5" (36.8 cm) space between.



Articulating Arm Support #A-71319

- Prone arm support
- Simple adjustability
- Patient Weight Capacity: 600 lbs (272 kg)
- Telescoping arm platform adjusts length
- Soft visco elastic clamshell pad included
- Requires clamp (sold separately)
- Pads included

Included



#A-71319
Articulating Arm Support
1 Included

What's Required



#A-71320
Articulating Arm Support Clamp
10" (25.4 cm)
2 Required

What's Optional



#A-71321
Articulating Arm Support Replacement Pad



Advanced Arm Support #A-70615-US

- Prone arm support
- Fully adjustable
- Low profile
- Integral clamp
- Patient weight capacity: 500 lbs (227 kg)
- Expandable arm platform to adjust length
- Clamshell pad included

What's Included



#A-70615-US
Advanced Arm Support
1 Included



#O-AMA97X1.05
Clamshell Armboard
1" (2.5 cm) Pad
1 Included

Specify Rail Type

US	#A-70615-US
EU	#A-70615-EU
UK	#A-70615-UK
Japan	#A-70615-JP
Denyer	#A-70615-DEN



Prone Arm Support #A-70610

- Prone and lateral arm support
- Free ulnar nerve
- Low profile
- Contoured hand rest
- Patient Weight Capacity: 500 lbs (227 kg)
- Pad included

Included



#A-70610
Prone Arm Support
1 Included

What's Required



#A-40022 (US)*
Easy Lock® Socket
1 Required



#A-70500 (US)*
Flex Frame Armboard Rail
1 Required

Optional



#A-AMA74
LPS Arm Support Replacement Pad

*Specify Rail Type: US, EU, UK, JP, DEN. See product page for international part numbers.



Easy Armboard With Trigger #O-ABSLT **CE**

With the trigger design, simply pull the radiolucent release mechanism for full articulation and release it to lock. A spring lever accessible from both sides securely locks the armboard to the rail. Armboard measures 26" x 5.5" (66 x 14 cm). The pad width measures 6" (15.2 cm). Patient Weight Capacity: 400 lbs (181 kg). Pad not included.

What's Required *Choose One*



#O-AMA96X2.05
Clamshell Armboard
2" (5 cm) Pad
1 Required



#O-AMA96X3.05
Clamshell Armboard
3" (7.6 cm) Pad
1 Required

What's Optional



#(multiple)
Polymer Gel Pads
Call Sales Dept. for part numbers



#(multiple)
Pressure Management Pads
Call Sales Dept. for part numbers

Specify Rail Type

- US** #O-ABSLT
- EU** #O-ABSLTE
- UK** #O-ABSLTUK



Multi-Task Armboard #O-ABMT **CE**

Provides arm support for lateral, chair, prone and neuro park bench positions. Lockable ball socket combined with 6" (15.2 cm) of horizontal travel permits a wide range of positioning flexibility. Patient Weight Capacity: 500 lbs (227 kg).

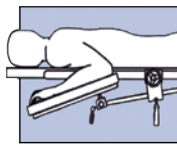
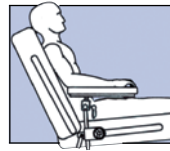
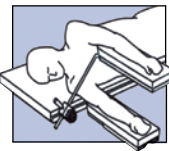

What's Required *Choose One Pad*



#A-40022 (US)*
Easy Lock® Socket
1 Required



#O-AMA97X1.05
Clamshell Armboard
1" (2.5 cm) Pad
1 Required

OR



#O-AMA12X1.05
Standard Armboard
1" (2.5 cm) Pad
1 Required

*Specify Rail Type: US, EU, UK, JP, DEN. See product page for international part numbers.



Allen® Advance Flat Top Pad #A-70436

A one-piece 3" (7.6 cm) thick pressure management pad for the Allen Advance Flat Top. This pad has the added benefit of Allen's patented multi-layer foam pressure management design.

#A-70436 82" x 20" x 3" (208 cm x 51 cm x 7.6 cm)



Supine Top Set #A-70400

Radiolucent sections that convert an open spine frame to a solid imaging surface. Patient Weight Capacity: 500 lbs (227 kg).

What's Included



#A-70400
Supine Top Set
4 Included

What's Required *Choose One*



#A-70434
Astrus Elite™ Supine
Top Set Pads
12" x 20" x 2"
(30.5 cm x 50.8 cm x 5 cm)
4 Required



#A-70435
Astrus Elite Supine
Top Set Pads
12" x 20" x 3"
(30.5 cm x 50.8 cm x 7.6 cm)
4 Required



Astrus Elite Supine Top Pad #A-70434, #A-70435

Patented pressure management pads for use with the A-70400 Supine Top Set.

#A-70434 12" x 20" x 2" (30.5 cm x 50.8 cm x 5 cm)

#A-70435 12" x 20" x 3" (30.5 cm x 50.8 cm x 7.6 cm)



Bow® Frame Skin Care Covers Kit

#A-70810

Skin Care Cover disposables are for use with the Allen® Bow Frame. They are comprised of moisture-absorbing foam and a low shear backing. The covers are used to help protect the Bow Frame pads from fluids and contaminants.

Each set includes foam head support, two arm supports, frame cover, rod support cover and body support covers. (Sold In Cases Of 6 Sets)



Bow Frame Skin Care Covers #A-70810C

Skin Care Cover disposables are for use with the Allen Bow Frame. They are comprised of moisture-absorbing foam and a low shear backing. The covers are used to help protect the Bow Frame pads from fluids and contaminants.

Each set includes frame cover, rod support cover and body support covers. (Sold In Cases Of 6 Sets)



Bow Frame Standard Covers Kit #A-70805

Disposable covers for use with the Allen Bow Frame. These covers are used to help protect the Bow Frame pads from fluids and contaminants.

Each set includes foam head support, two arm supports, frame cover, rod support covers and body support covers. (Sold In Cases Of 6 Sets)



Allen® Advance Ultra Comfort Covers **CE**

#A-71261, #A-71262, #A-71263

Allen Advance Ultra Comfort Covers are for use with the Allen Advance Prone Support Pads for patients in the prone position. They are comprised of moisture-absorbing foam with a shear reducing backing to help alleviate horizontal shear pressures.

#A-71261 Small (Sold In Cases Of 6 Sets)

#A-71262 Medium (Sold In Cases Of 6 Sets)

#A-71263 Large (Sold In Cases Of 6 Sets)



Comfort Cover Disposables #A-70260 **CE**

Comfort Covers are for use with wingsets for patients in the prone position. They are comprised of a moisture-absorbing foam with a low shear, Tyvek® backing. (Sold In Cases Of 5 Sets - 4 Pieces Per Set)

Single use.



Allen Foam Head Block #A-70862 **CE**

Allen Foam Head Blocks are used to support the head in prone procedures. They can be used with the C-Flex® Head Positioning System, the Allen Foam Block Stand, the Allen Advance Table Head Plate or any flat surface. They are comprised of a supportive bottom foam layer and top layer of much softer foam that is designed to contact the patient's face. (Sold In Cases Of 6)

Single use.



Comfort Mask Disposables #A-70310 €€

Comfort Mask Disposables are for use with C-Prone and C-Flex® Head Positioning System. It is designed to reduce maceration and shear forces on the skin while cradling the face of patients in the prone position. They are comprised of a cosmetic, moisture-absorbing foam that is soft on the face. (Sold In Cases Of 5)

Single use.



C-Prone Head Positioner #A-70300 €€

- Prone head positioner
- Vertical and rotational adjustment
- Patient Weight Capacity: 500 lbs (227 kg)
- Fits the Allen® Advance Table and Allen Flex Frame
- Fits the Mizuho OSI Modular Table System*
- Fold away mirror
- Easy airway access

*Compatible with rails that are 1.25" (3.2 cm) wide x 1.5" (3.8 cm) tall with a 14.5" (36.8 cm) space between.

What's Included



#A-70300
C-Prone
Head Positioner
1 Included



#A-70310
Comfort Mask Disposables
Case of 5 Included

What's Required



#A-70310
Comfort Mask Disposables
Case of 5



Foam Head Block Stand #A-70825 €€

The Foam Head Block Stand is used in collaboration with a Foam Head Block to support a patient's head. This stand can be used on any flat surface rated to hold patient weight. The cutout and mirror allow anesthesiologists to be able to view the eyes and airway during a procedure. Patient Weight Capacity: 500 lbs (227 kg).

What's Included



#A-70825
Foam Head Block Stand
1 Included

What's Required



#A-70862
Allen Foam Head Block
Case of 6



Advance Accessory Cart #A-71600

The Allen® Advance Table Accessory Cart stores the surgical platforms and the accessories used with the Allen Advance Table. The platforms store safely and securely in custom slots within the cart while additional molded shelving offer ample space to store all the of the table's additional accessories.



Bow® Frame Cart #A-70815

The Bow Frame Cart stores all of the accessories used with the frame, including the head positioner and arm supports. The Bow Frame stores securely in the deep bin of the cart. The cart's weighted base makes it tip-resistant and reduces potential vibration during transport. Polymer base is dent-resistant. Heavy-duty casters roll smoothly. Two casters lock for safe and easy loading, unloading and storage.



Specify Rail Type

US #A-70815
EU #A-70815-EU

UK #A-70815-UK
Japan #A-70815-JP



Gyn / Uro / Lap

Nothing Compares



Over 30 years providing safe, reliable lithotomy solutions



More than 50,000 stirrups sold



Two year warranty included on all new stirrup purchases



Robust service & repair program to protect your purchase *US only*





		Lift Mechanism	Lithotomy Adjustment (From Sterile Field)	Lithotomy Range (From Sterile Field)	Abduction Adjustment (From Sterile Field)	Abduction Range (From Sterile Field)	Lithotomy Indicator	Patient Weight Capacity	Protective Fin Design	Extended Warranty
Fins (With Lateral Fin)	Ultrafins® #O-UFAS	Y	Y All Positions in Range	+84, -33	Y All Positions in Range	+25, -9	Y (on lift-assist mechanism)	800 lbs (363 kg)	Y	Y
	Yellofins® Elite #O-YFES	Y	Y All Positions in Range	+84, -33	Y All Positions in Range	+25, -9	Y (on lift-assist mechanism)	500 lbs (227 kg)	Y	Y
	Yellofins® #O-YFASI	Y	Y All Positions in Range	+84, -33	Y All Positions in Range	+25, -9	Y (on lift-assist mechanism)	350 lbs (159 kg)	Y	Y
	Yellofins® (without Lift-Assist™) #O-YFSI	N	Y All Positions in Range	+90, -35	Y All Positions in Range	+25, -9	N	350 lbs (159 kg)	Y	Y
No Fins	PAL Pro® #A-10052	Y	Y All Positions in Range	+90, -22	Y All Positions in Range	+25, -9	Y (on handle)	350 lbs (159 kg)	N	Y
Pediatric	Junior PAL® #A-10056	N	Y All Positions in Range	+90, -35	Y All Positions in Range	+25, -9	N	250 lbs (113 kg)	N	Y
	Little PAL® #A-10057	N	Y All Positions in Range	+90, -35	Y All Positions in Range	+25, -9	N	160 lbs (73 kg)	N	Y

Extended Warranty Program For Stirrups - US Only

Keep your stirrups functioning like new for four full years. Purchase the Extended Warranty and Allen® Medical will extend the original warranty for an additional two years (four years total) for stirrup hardware. This program ensures that the stirrup functions properly for four years from the date of purchase. Boot pads are not covered by Extended Warranty programs.

See page 139 for more information on Allen Medical System's Warranty Program.



Ultrafins® Stirrups

Supports up to 800 lbs (363 kg)



Patient Weight Capacity:
800 lbs (363 kg)



Flexible Boot



Clamshell Pad Shown

Ultrafins® Stirrups #O-UFAS

Easily Accommodates Patients With Larger Calves. 800 lbs (363 kg) Patient Weight Capacity.

The Ultrafins Stirrup is an upgrade of the Yellofins® Stirrup. The reinforced rod and joint assembly and the flexible boot make the system capable of positioning a patient weighing up to 800 lbs (363 kg). Though designed for large patients, the Ultrafins Stirrup is still appropriate for use with the general patient population.

- **Patient Weight Capacity: 800 lbs (363 kg):** Support lithotomy positioning for very large patients
- **Flexible Boot:** Boot comfortably conforms to the calf shape of the patient while providing support
 - The shape and design of the back of boot helps reduce pressure under the popliteal fossa
 - Flexible boot allows these stirrups to be standardized throughout the facility
- **Fin Design:** Covers the fibula head and helps to protect superficial peroneal nerve
- **Floating Boot:** Self-adjusting boot minimizes pressure on the calf when moving the stirrup
- **Lift-Assist™ Technology:** Allows easy movement of the leg when placing it in the desired position
- **Ultrafins Clamshell Pad:** Completely encapsulates the foot, ankle and calf for comfortable and secure positioning
- **Squeeze Grip Handle:** Provides easy intraoperative adjustment without compromising the sterile field. Simply release the handle to secure the leg holder in all directions.
- **Lithotomy Range:** Set the stirrup in any position between +84° to -33° lithotomy
- **Abduction Range:** Set the stirrup in any position between +25° to -9° abduction
- **Lithotomy & Length Indicators:** Help ensure precise positioning

What's Included



#O-UFAS
Ultrafins Stirrups
1 Pair Included



#O-AMA65S0.6S
Ultrafins Clamshell Pad
1 Pair Included

What's Required



#A-40040 (US)*
Easy Lock® Blade Clamp
2 Required



#A-22000
Safety Drape
Case of 10 Pairs

What's Optional



#A-30015
Stirrup Cart



Easy Catcher®
Disposable System
Case of 10
See page 63



#A-XWARUF
Extended Warranty
Available in US Only

*Specify Rail Type: US, EU, UK, JP. See product page for international part numbers.
Pads included.

Yellofins® Elite Stirrups

Supports up to 500 lbs (227 kg)



Yellofins® Stirrups

Supports up to 350 lbs (159 kg)



Easily Grip & Squeeze



Raise & Abduct

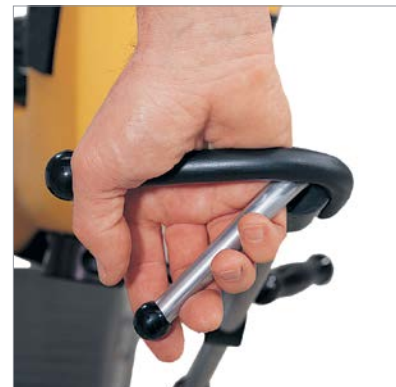

Squeeze & Position

Yellofins® Stirrups CE

Simultaneous Lithotomy And Abduction

The Yellofins Stirrup represents the gold standard in lithotomy positioning. Yellofins Stirrups allow for easy adjustment of abduction and lithotomy while maintaining the sterile field. The boot is extended along its lateral side (referred to as a "lateral fin") and is padded on the interior. The purpose of this fin is to cover and protect the head of the fibula and the peroneal nerve. The Yellofins Stirrup enables safe and easy positioning while providing enhanced surgical site access.

- **Boot Design:** Extended lateral fin is designed to cover and protect the head of the fibula and the peroneal nerve
- **Floating Boot:** Self-adjusting boot minimizes pressure on the calf when moving the stirrup
- **Lift-Assist™ Technology:** Allows easy movement of the leg when placing it in the desired position
- **Yellofins Reusable Pad:** Completely encapsulates the foot, ankle and calf for comfortable and secure positioning
- **Squeeze Grip Handle:** Provides easy intraoperative adjustment without compromising the sterile field. Simply release the handle to secure the leg holder in all directions
- **Lithotomy Range:** Yellofins and Yellofins Elite with Lift-Assist technology – Set the stirrup in any position between +84° to –33° lithotomy. Yellofins without Lift-Assist technology – Set the stirrup in any position between +90° to –35° lithotomy.
- **Abduction Range:** Set the stirrup in any position between +25° to –9° abduction
- **Lithotomy & Length Indicators:** Visual indicators that help ensure precise positioning

What's Included *Choose Your Stirrups*



#O-YFES
Yellofins Elite Stirrups
with Lift-Assist
1 Pair Included



#O-YFASI
Yellofins Stirrups
with Lift-Assist
1 Pair Included



#O-YFSI
Yellofins Stirrups
without Lift-Assist
1 Pair Included

What's Required



#O-AMA68S0.6S
Yellofins Reusable Pad
1 Pair Required



#A-40040 (US)*
Easy Lock® Blade Clamp
2 Required



#A-22000
Safety Drape
Case of 10 Pairs

What's Optional



#A-30015
Stirrup Cart



Easy Catcher®
Disposable System
Case of 10
See page 63



#A-XWARYFPRO
Extended Warranty
Available in US Only

*Specify Rail Type: US, EU, UK, JP. See product page for international part numbers.
Pads not included.

PAL Pro® Stirrups
Supports up to 350 lbs (159 kg)



Lift-Assist™ Technology



Lithotomy Range: +90° to -22°



FootHugger™ Boot Pad

PAL Pro® Stirrups #A-10052

The Power Of Safety And Control At Your Fingertips

The PAL Pro Stirrup is the most feature-rich Allen® stirrup utilizing a standard boot. The stirrup allows for easy adjustment of abduction and lithotomy while maintaining the sterile field. The PAL Pro stirrup is differentiated from the Yellofins® Stirrup by boot design, mechanism cover, the type of hand control and lithotomy indicator.

- **Floating Boot:** Self-adjusting standard boot minimizes pressure on the calf when moving the stirrup
- **Lift-Assist™ Technology:** Allows easy movement of the leg when placing it in the desired position
- **Handle:** Provides easy intraoperative adjustment without compromising the sterile field. Simply release the handle to secure the leg holder in all directions.
- **Lithotomy Range:** Set the stirrup in any position between +90° to -22° lithotomy
- **Abduction Range:** Set the stirrup in any position between +25° to -9° abduction
- **Lithotomy & Length Indicators:** Visual indicators help ensure precise positioning
- **Mechanism Cover:** Easy to clean the stirrup between cases
- **Patient Weight Capacity:** 350 lbs (159 kg)

What's Included



#A-10052
PAL Pro
1 Pair Included

What's Required



#A-10028-C
FootHugger™ Boot Pad
1 Pair Required



#A-40040 (US)*
Easy Lock® Blade Clamp
2 Required



#A-22000
Safety Drape
Case of 10 Pairs

What's Optional



#A-30015
Stirrup Cart



Easy Catcher®
Disposable System
Case of 10
See page 63



#A-10319
Velcro® Straps for Stirrups
Set of 4



#A-XWARYFPRO
Extended Warranty
Available in US Only

*Specify Rail Type: US, EU, UK, JP. See product page for international part numbers.
Pads not included.



Little PAL® Stirrups

Patients ages 3-6 years old
Supports up to 160 lbs (73 kg)



Junior PAL® Stirrups

Patients ages 7-11 years old
Supports up to 250 lbs (113 kg)



Junior PAL® & Little PAL® Pediatric Stirrups CE

Effective, Natural Design Fits Pediatric Anatomy

Easy to use, comfortable and secure leg positioning for pediatric patients. Simultaneous abduction and lithotomy adjustments are easily made via a single handle while maintaining the sterile field. Boot is adjusted with a single clamp making positioning simple.

- **Pediatric Boot Design:** Special boot design to fit pediatric anatomy and cradles the pediatric calf, ankle and heel in a natural position
- **Floating Boot:** Self-adjusting standard boot minimizes pressure on the calf when moving the stirrup
- **Reusable Clamshell Pad:** Completely encapsulates the foot, ankle and calf to help protect, cushion and reduce pressure on these areas
- **Visual Indicators:** Help to ensure precise positioning
- **Lithotomy Range:** Set the stirrup in any position between +90° to -35° lithotomy
- **Abduction Range:** Set the stirrup in any position between +25° to -9° abduction

#A-10055 Pediatric Stirrups Package (1 Pair Junior PAL + 1 Pair Little PAL)

#A-10056 Junior PAL Stirrups (1 Pair)

#A-10057 Little PAL Stirrups (1 Pair)

Stirrup Options *Choose One*



#A-10056
Junior PAL Stirrups
1 Pair



#A-10057
Little PAL Stirrups
1 Pair

What's Included *Choose One*



#A-10058
Junior PAL Clamshell Pad
1 Pair Included



#A-10059
Little PAL Clamshell Pad
1 Pair Included

What's Required *Choose One*



#A-40040 (US)*
Easy Lock® Blade Clamp
2 Required



#O-RC2 (US)**
Rail Clamp
2 Required

What's Optional



#A-30015
Stirrup Cart



Easy Catcher®
Disposable System
Case of 10
See page 63



#A-XWARPALSAM
Extended Warranty
Available in US Only

*Specify Rail Type: US, EU, UK, JP.

**Specify Rail Type: US, EU, UK, JP, DEN, SWISS.

See product page for international part numbers.

Pads included.



Integral Straps



Safety Vacuum Valve
(Not Sold Separately)



Waterproof Disposable Cover

Allen® Hug-U-Vac® Steep Trend Positioners CE

Ideal For Use With Robotic Procedures

The Allen Hug-U-Vac Steep Trend Positioners safely and comfortably hold patients in the steep Trendelenburg which is common in robotic procedures. The Allen Hug-U-Vac Positioner's unique pliable design enables it to conform to the patient's entire supine anatomy to create a larger surface area to cradle the body during steep Trendelenburg. The Hug-U-Vac Positioners have integral quick-release straps that enable it to attach tightly to the rails of standard OR tables. The Large Hug-U-Vac Steep Trend Positioner has been designed with three chambers to accommodate larger patients.

Ideal for use with Gynecology Procedures, Urology Procedures, Robotic Surgical Procedures, Colorectal Procedures, Cholecystectomies.

- No continuous suction required
- Patient weight capacity: 500 lbs (227 kg)
- Enables secure positioning in robotic procedures
- Designed for easy forearm access to IV lines
- Integral straps secure to standard OR table rails
- Valve location designed for quick access to anesthesia
- Lightweight for easy transport, set-up, and storage
- Durable vacuum valve with on/off switch and lock
- Disposable slipcovers are waterproof for easy clean-up

#A-60010 Steep Trend Positioners Package
Includes Allen Hug-U-Vac Steep Trend Positioner and Allen Hug-U-Vac Large Steep Trend Positioner

#A-60001 Allen Hug-U-Vac Steep Trend Positioner (500 lbs / 227 kg Capacity)
Device Dimensions: 46" x 42" (116.8 cm x 106.7 cm) Device Weight: 8 lbs (3.6 kg)

#A-60005 Allen Hug-U-Vac Large Steep Trend Positioner (500 lbs / 227 kg Capacity)
Device Dimensions: 51" x 54" (129.5 cm x 137.1 cm) Device Weight: 10 lbs (4.5 kg)

What's Included *Choose A Size*



#A-60001
Allen Hug-U-Vac
Steep Trend Positioner



#A-60005
Allen Hug-U-Vac Large
Steep Trend Positioner

What's Required *Steep Trend*



#A-63600
Allen Steep Trend
Secondary Supports
1 Pair Required

+



#A-40040 (US)*
Easy Lock® Blade Clamp
2 Required



#A-60101
Steep Trend Positioner
Disposable Covers
Case of 12

What's Required *Large Steep Trend*



#O-RSX2
Allen Large
Security Strap
1 Required

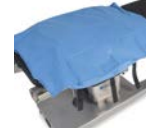

#A-60105
Large Steep Trend Positioner
Disposable Covers
Case of 12

What's Optional



#O-YFES
Yellofins® Elite with Lift-Assist™
1 Pair



#C-008001
Replacement C-Clip
Hug-U-Vac



#O-PRSH
Patient Security Strap Hooks
6 Required for #A-60001, 8 Required for #A-60005

*Specify Rail Type: US, EU, UK, JP. See product page for international part numbers.



Easy On, Easy Off



Flexible Band For Increased Site Access



Fully Disposable



All-In-One System

Easy Catcher® Disposable System CE

#O-EC51, #O-EC52

Easy To Use & Fully Disposable Single Use System

The Allen® Easy Catcher is designed to catch and drain fluid during a surgical procedure. It attaches to the side rails of a standard OR table via two integral rail clamps. The Easy Catcher is a single-piece system that contains a fluid drain drape with an integral flexible support band. The band supports the drape vertically for optimal drainage. The support band also flexes to accommodate the doctor's mid-section during procedures. The all-in-one system is fully disposable making it more convenient and quicker to set-up and dispose of.

- All-in-one fluid containment system
- Saves clean-up time
- Fully disposable
- Flexible integrated band
- Easy set-up and removal
- Integral clamps for easy set-up
- Single-piece system includes: buttocks flap, mesh trap, collapsible hose and removable tube adaptor
- Maximize infection control with disposable system
- Attaches to the rails of a standard OR table
- Eliminates the need to clean system band for repeated use
- No more lost or damaged bands
- Removable tube adaptor connects to a variety of fluid waste management systems

Ideal for use with a variety of urology and gynecology procedures including Cystoscopy, Ureteroscopy, Urologic Oncology, Pediatric Urology, Calculi (urinary tract stones) and Neurourology.

What's Included *Choose One*



#O-EC51 (US)
Sterile Easy Catcher
Disposable System
Case of 10



#O-EC52 (US)
Non-Sterile Easy Catcher
Disposable System
Case of 10

Specify Rail Type

	Sterile	Non-Sterile
US	#O-EC51	#O-EC52
EU	#O-EC51-EU	#O-EC52-EU
UK	#O-EC51-UK	#O-EC52-UK



Disposables Sold Separately

Uro Catcher® System #O-UC4 **CE**

Provides excellent fluid containment for hysteroscopy or cysto procedures on the OR table. Flexible drape support frame provides unobstructed surgeon access during manipulation and springs back to its original state to facilitate optimal fluid drainage. Mounts easily with integral rail clamps to side rails and maintains its funnel shape.

Specify Rail Type

US	#O-UC4	Denyer	#O-UC4DEN
EU	#O-UC4E	Japan	#O-UC4J
UK	#O-UC4UK		

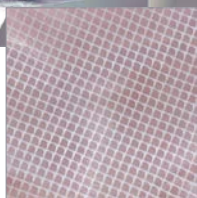

Open Mesh

Uro Catcher Drapes #O-UC31, #O-UC32 **CE**

Open mesh filter allows for fast drainage of fluids. The flexible drain hose is compatible with most suction systems for accurate fluid measurement and metering. Velcro® securement eliminates the need to use tape. Durable drape has flexible hose. Length of tubing is 64" (162.5 cm) extended, 20" (50.8 cm) compressed. Tubing diameter is .875" (2.2 cm).

#O-UC31	Sterile Drape (Sold In Case Of 10)
#O-UC32	Non-Sterile Drape (Sold In Case Of 10)



Ultra-Fine Mesh

Brachytherapy Drapes for Uro Catcher System

#A-50008 **CE**

Our ultra-fine mesh trap is designed to catch even very small particles while allowing fluid to drain through. The flexible drain hose is compatible with all suction systems for accurate fluid measurement and metering. Velcro securement eliminates the need to use tape. Durable drape has flexible hose. Length of tubing is 64" (162.5 cm) extended, 20" (50.8 cm) compressed. Tubing diameter is .875" (2.2 cm).

#A-50008	Sterile Drape (Sold In Cases Of 10)
----------	-------------------------------------

Easy Irrigation Tower #O-LPA

Lift-Assist™ Technology Neutralizes Irrigation Bag Weight

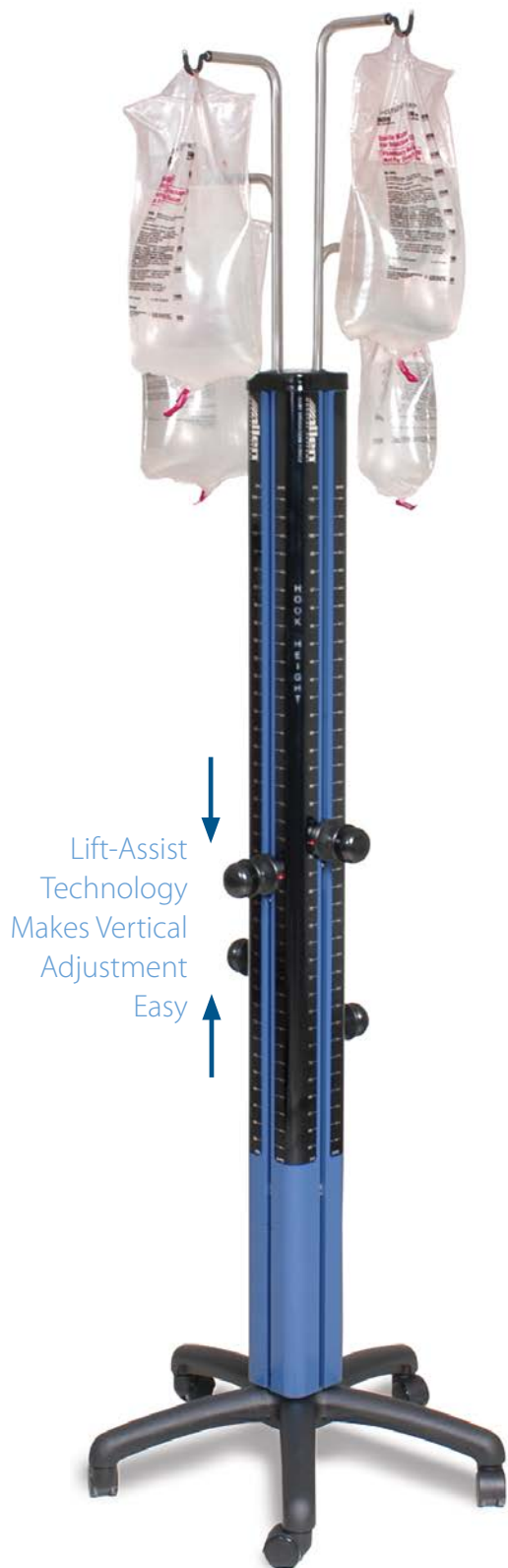

Lift-Assist
Technology
Makes Vertical
Adjustment
Easy

Four independently adjustable hooks each safely support up to 10,000cc of fluid. Comfortable, quick-release knobs permit vertical adjustment of hangers from 5.5' to 8.5' (1.67 m to 2.59 m). This nurse-friendly design makes it easy for personnel to operate.

- **Stable:** Our tower doesn't require sandbags or special weights to stay up
- **Nearly Effortless:** Lift-Assist technology makes vertical adjustment easy
- **Simple:** Spring design
NO complicated hydraulics to fail
NO battery to remember to charge
- **High Capacity:** Holds up to 40,000cc (10,000cc max capacity per hook)
- **User-Friendly:** Easy-to-reach hangers range from 5.5' to 8.5' (1.67 m to 2.59 m)
- **Convenient:** Four independently adjustable hooks
- **Ergonomic:** Comfortable, quick-release knobs



Lift-Assist Technology

Unique spring-loaded elliptical knob unlocks when squeezed and locks securely in place when released. The Lift-Assist articulation is done mechanically; there are no hydraulics or batteries to fail.



Accuracy

The hanger height is displayed in inches and centimeters for your convenience.



Shoulder Supports #A-63500 **CE**

Used for procedures requiring the Trendelenburg position. Includes thick foam padding with our flexible cover. Patient Weight Capacity: 500 lbs (227 kg).

What's Required



A-40040 (US)*
Easy Lock® Blade Clamp
2 Required

What's Optional



Replacement Pads
(Left & Right)
#A-63500PAD

*Specify Rail Type: US, EU, UK, JP. See product page for international part numbers.



Integral Rail Clamp

Table Width Extender 4" (10 cm) #O-TWE **CE**

Increases the support surface for larger patients. Clips easily with integral locking mechanism to the rail. Can be used individually or in multiples to create a custom platform. Support surface measures 4" x 20" (10 cm x 51 cm). Includes side rail for mounting stirrup clamps, armboards and other accessories. Call Sales Dept. for replacement pad info. Patient Weight Capacity: 400 lbs (181 kg).

Specify Rail Type

US #O-TWE
EU #O-TWEE
UK #O-TWEUK

Pad Sizes

1" (2.5 cm) #O-AMA34X1.0S
2" (5 cm) #O-AMA34X2.0S
3" (7.6 cm) #O-AMA34X3.0S
4" (10 cm) #O-AMA34X4.0S



Pads Included

Simplicity™ Knee Crutch #O-KCP **CE**

Provides excellent patient comfort and precise surgical positioning for short duration procedures. Soft, flexible pad reduces popliteal pressure. Easy-to-use handle provides vertical adjustment from 16" to 21" (40.5 cm to 53 cm) and 360° horizontal rotation. Includes Velcro® strap for security. Patient Weight Capacity: 400 lbs (181 kg). (Sold In Pairs)

What's Required *Choose One*



#A-40022 (US)*
Easy Lock® Socket
2 Required



#A-40016 (US)*
Tri-Clamp
2 Required

What's Optional



#O-KCPP
Replacement Pads
1 Pair

*Specify Rail Type: US, EU, UK, JP, DEN. See product page for international part numbers.



Integral Clamps

Nissen Thigh Straps #O-NTS **CE**

Secure patients from sliding during steep reverse Trendelenburg procedures such as Nissen Fundoplication. Conductive straps encircle each upper thigh with a broad soft pad. Airplane style buckle permits convenient length adjustment. Pad is 4.5" (11.4 cm) wide and 20" (51 cm) long. Straps are adjustable up to 48" (122 cm). Patient Weight Capacity: 500 lbs (227 kg). (Sold In Pairs)

Specify Rail Type

- | | | | |
|-----------|----------|---------------|-----------|
| US | #O-NTS | Japan | #O-NTSJ |
| EU | #O-NTSE | Denyer | #O-NTSDEN |
| UK | #O-NTSUK | | |



Clamshell Boot Pads #O-AMA62S0.6S **CE**

These replacement boot pads will fit in our Direct Placement Stirrup, Banana Boot™ Stirrup, Basic Stirrup, Infinity Stirrup, Infinimax Stirrup and Well-Leg Holder. (Sold In Pairs)



Quick Release Heel Cup

The Twister™ Device #O-LHPCCA **CE**

An improved "Candy Cane" design with greater leg clearance. Constructed of stainless steel for smooth operation and improved reliability. Strong rotation lock prevents slippage and permits vertical adjustment from 28" to 41" (71 cm to 104 cm). Patient Weight Capacity: 500 lbs (227 kg). (Sold In Pairs)

Required



#A-40022 (US)*
Easy Lock® Socket
2 Required

What's Optional



#O-TSPP
Support Pole Pads
1 Pair



#O-HC
Heel Cups
1 Pair



#O-CCPS
Replacement
Straps

*Specify Rail Type: US, EU, UK, JP, DEN. See product page for international part numbers.



Orthopaedics

Allen® Lift-Assist® Beach Chair #A-91500 CE



Lightweight With Lift-Assist™ Technology To Make Positioning Easy

The Lift-Assist Beach Chair is designed for use with orthopaedic procedures using the Fowler's or beach chair position. The chair offers unobstructed access and the Lift-Assist mechanism makes repositioning the patient quick and easy. The Lateral Slide feature enables the surgeon to move the patient closer to the edge of the OR table for increased surgical site access. The Lift-Assist Beach Chair weighs under 30 lbs (13.6 kg) without the back support panels installed.

- Attaches to the rails of standard OR tables
- 500 lbs (227 kg) patient weight capacity
- Lateral adjustment - improved surgical site access
- Lightweight - for single person set-up and removal
- Rail width 20" - 26" (50.8 cm - 66 cm) - fits a wider range of OR tables
- Spring Lock Quick Connect - easy installation and removal of head positioners
- Rail clamp indicators - display when the Beach Chair is properly installed on the OR table rails
- Small rail clamp footprint - frees up accessory rail space needed for different procedures
- No gas spring cables to repair or break
- Removable back panels increases access to surgical site
- Low-cut backboard - excellent maneuverability during total shoulder procedures
- Optional head positioner lock helps support patient's neck



Lift-Assist Pistons Make Positioning Patients Easy



Adjust The Patient Using Lift-Assist™ Handle

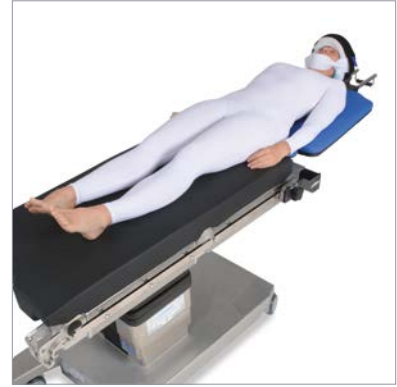

Chair Lies Flat For Clear Anesthesia Access

Unobstructed Posterior & Lateral Access



What's Included



#A-91501
Allen® Lift-Assist®
Beach Chair and Pad Set
1 Included



#A-91502
Intubation Plate
and Pad
1 Included



#A-91503 (US)*
Lift-Assist Beach
Chair Clamp
2 Included

What's Required

Counter Traction



#A-90015
Counter Traction Strap
1 Required

+



#A-40022 (US)**
Easy Lock® Socket
1 Required

Headrest & Disposables



#A-90026
Universal™ Head
Positioner
1 Required

+



#A-90023
Universal Head
Restraint Disposables
Case of 10

Arm Support *Choose One Arm Support*



#A-90002
LPS Arm Support
1 Required

OR



#O-ABMT
Multi-Task Armboard
1 Required

+



#O-AMA97X1.05
Clamshell Armboard
Pad
1 Required

+



#A-40022 (US)**
Easy Lock Socket
1 Required

What's Optional



#A-90100 (US)**
Beach Chair Cart



#A-92000
Allen Arm Positioner



#O-LPA
Allen Easy Irrigation Tower



#A-90040
Replacement Reusable Pad Set

*Specify Rail Type

US #A-91503
EU #A-91503EU

UK #A-91503UK
Japan #A-91503JP

**Specify Rail Type: US, EU, UK, JP, DEN. See product page for international part numbers.



Universal™ Head Positioner



Adjusts Intraoperatively



Easy To Use Disposable



Single Knob
Releases All Joints

Universal™ Head Positioner #A-90026 CE

Easy To Use And Protective Head Positioning For The Beach Chair Position On The Operating Room Table

The Allen® Universal Head Positioner supports the patient's head and neck providing adjustability and ease of positioning. Designed for simple set-up and use. It supports the patient's unique anatomy securely and comfortably and offers more versatility than competitive head supports.* In addition, the disposable straps which support the head and neck are comprised of wide soft protective padding. Straps are designed to distribute force to help reduce the risk of pressure injuries.

Ideal for use with most upper extremity procedures in the beach chair position.

- Multiple straps for secure control of patient's head and neck
- Single knob releases all joints
- Easy intraoperative adjustments
- Adjustable to help accommodate the patient's head
- Disposable wide soft straps minimize pressure on skin
- Lightweight and portable
- Simple set-up, easy to use
- Secure head and neck with ability to lock the desired position
- Compatible with all Allen Beach Chairs
- Device Weight (without disposable): 3.4 lbs (1.5 kg)
- Patient Weight Capacity: 500 lbs (227 kg)

What's Included



#A-90026
Universal Head Positioner
1 Included

What's Required



#A-90023
Universal Head
Restraint Disposable
Case of 10

What's Optional



#A-91500
Lift-Assist® Beach Chair



#A-90100 (US)**
Beach Chair Cart



#A-90025
Replacement Straps

*Based on a feature comparison to Linvatec®, McConnell and Mizuho OSI beach chair head rests. (January 22, 2010)

**Specify Rail Type: US, EU, UK, JP, DEN. See product page for international part numbers.



Unobstructed Access



Multiple Positions



External Rotation & Abduction

Simple &
Lightweight



Allen® Arm Positioner #A-92000 CE

Spend Your Time On The Procedure, Not The Positioning

The Allen Arm Positioner delivers easy arm positioning for shoulder surgery in the Beach Chair position, as well as elbow and clavicle procedures. By indexing at the elbow, the device is able to gain complete positioning control of the shoulder joint. The revolutionary patent pending design allows the entire device to be steam sterilized and provides an unobstructed access to the surgical site. The device also has the capability of achieving a semi-locked state allowing the surgeon to simply move the arm where he wants it without having to adjust the tension.

Ideal for use with all open and arthroscopic upper limb procedures.

- No foot pedal, no hoses, no hydraulics, no power cords
- The only fully autoclavable arm positioner on the market
- Single knob releases all joints
- Lightweight device weighs only 6 lbs (2.7 kg). No cart required.
- Easy, fluid positioning for enhanced site access
- Connects over the drape, in the sterile field
- Compact and portable for easy storage
- Index at the elbow for complete control
- Quick and easy set-up
- Unobstructed access to the surgical site (no bars or foot pedal obstructions)
- Patient Weight Capacity: 500 lbs (227 kg)

What's Included



#A-92000
Allen Arm Positioner
1 Included

What's Required



#A-92001
Allen Arm Positioner
Sterile Disposable
Case of 10



#A-92002
Autoclavable Clamp
1 Required

What's Optional



#A-91500
Lift-Assist® Beach Chair



#A-90100 (US)*
Beach Chair Cart



#A-92003
Replacement Arm Support

*Specify Rail Type: US, EU, UK, JP, DEN. See product page for international part numbers.



Multi-Task Armboard #O-ABMT

Provides arm support for lateral, chair, prone and neuro park bench positions. Lockable ball socket combined with 6" (15.2 cm) of horizontal travel permits a wide range of positioning flexibility. Patient Weight Capacity: 500 lbs (227 kg).



What's Required *Choose One Pad*



#A-40022 (US)*
Easy Lock® Socket
1 Required



#O-AMA97X1.05
Clamshell Armboard
1" (2.5 cm) Pad
1 Required

OR



#O-AMA12X1.05
Standard Armboard
1" (2.5 cm) Pad
1 Required

*Specify Rail Type: US, EU, UK, JP, DEN. See product page for international part numbers.



The Wrap-Around Pad Provides Protection & Stability

LPS Arm Support #A-90002

Provides comfortable and convenient placement of non-operative arm. Easy access to patient IV and enhanced stabilization of shoulder. Patient Weight Capacity: 500 lbs (227 kg).

What's Included



#A-90002
LPS Arm Support
1 Included



#A-AMA74
LPS Arm Support Pad
1 Included

What's Required



#A-40022 (US)*
Easy Lock® Socket
1 Required

*Specify Rail Type: US, EU, UK, JP, DEN. See product page for international part numbers.



FlexiForm™ Head Rest Pad Disposables CE

#A-90019

This disposable pad creates a more comfortable and protective environment for your patient. Required for use with the FlexiForm Head Rest. (Sold In Cases Of 10)



Universal Head Restraint Disposables CE

#A-90023

The Universal Head Restraint Disposable is designed for use with the Allen® Universal Head Positioner and Allen beach chairs during shoulder procedures, specifically in the Fowler's position. The disposable supports the patient's head and jaw helping align the neck in a natural position. (Sold In Cases Of 10)



Allen Arm Positioner Sterile Disposables CE

#A-92001

The Allen Arm Positioner Sterile Disposable is used exclusively with the Allen Arm Positioner. (Sold In Cases Of 10)

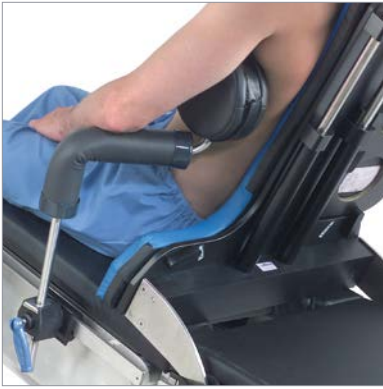

Counter-Traction Brace #A-90001 **CE**

Applied to operative side, the Counter-Traction Brace stabilizes patient for shoulder manipulation. For use with the Lift-Assist® Beach Chair.

What's Required



#A-40022 (US)*
Easy Lock® Socket
1 Required

*Specify Rail Type: US, EU, UK, JP, DEN. See product page for international part numbers.



Counter-Traction Strap #A-90015 **CE**

The Counter-Traction Strap supports the patient while they are in Fowler's position. For use with the Lift-Assist Beach Chair.

What's Required



#A-40022 (US)*
Easy Lock® Socket
1 Required

*Specify Rail Type: US, EU, UK, JP, DEN. See product page for international part numbers.



Beach Chair Reusable Pad Set #A-90020 **CE**

Pad Set For Use With The Allen® Beach Chairs #A-91000 & #A-90000

Combines high-density foam with a durable 4-way stretch cover for patient comfort.



Lift-Assist® Beach Chair Reusable Pad Set CE

#A-90040

Pad Set For Use With The Lift-Assist Beach Chair #A-91501

This pad set combines durable high-density foam with a 4-way stretch cover for patient comfort.



Allen® Beach Chair Cart #A-90100

The perfect companion, the Allen Beach Chair Cart conveniently stores the Allen Beach Chair and all of its accessories. The Beach Chair rests securely on sturdy rails at user height to help reduce potential back strain. Optional accessory hooks allow quick and easy storage for larger accessories. Deep bin affords plenty of extra storing space. Weighted base makes cart tip-resistant and reduces potential vibration during transport. Polymer base is dent-resistant. Heavy-duty casters roll smoothly. Two casters lock for safer and easier loading, unloading and storage.

What's Optional



Specify Rail Type
 #A-30011 (US)
 #A-30011E (EU)
 #A-30011J (Japan)

The Accessory Hook allows for faster product storage on our Accessory Cart. Coated prongs help protect stored product from developing scratches. Easy Lock® design makes attachment and detachment easy.

Specify Rail Type

US #A-90100
EU #A-90100E
Japan #A-90100J

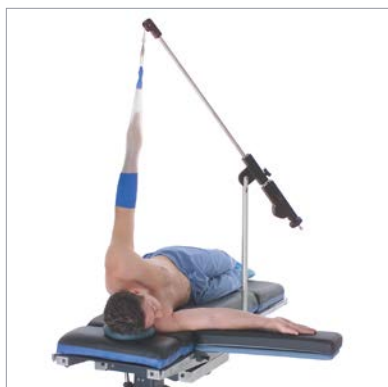

One Sterile Arm Trap Disposable Included

Weightless Shoulder Suspension System CE

#R-644-36

The Weightless Shoulder Suspension System allows for approximate traction settings up to 40 lbs (18.2 kg) with a simple turn of the tension adjustment knob. Boom arm adjusts from 0° to 90°. The boom head swivels so that its pulley always aligns properly with the cord. The system folds down for easy storage.

What's Required



#A-40018 (US)*
Simple Clamp
1 Required



#A-21200
Sterile Arm Trap Disposables
Case of 6

What's Optional



#A-30010 (US)*
Accessory Cart



#O-UPBL3S
Lateral Brace
3 Piece Set



#A-60003, #A-60002
Allen® Hug-U-Vac®
Lateral Positioner
Standard or Large



#O-LPA
Allen Easy
Irrigation Tower

*Specify Rail Type: US, EU, UK, JP, DEN. See product page for international part numbers.

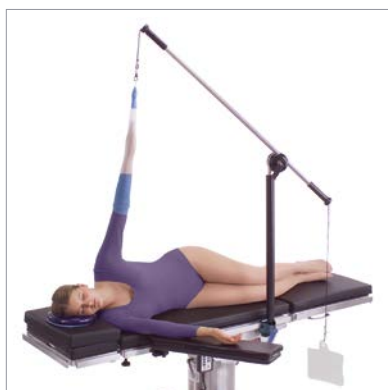

Weights Not Included

Arm Traction Device #A-20500 CE

Accommodates intraoperative traction up to 40 lbs (18.2 kg) for shoulder procedures. A mechanical safety stop helps prevent patient injury in the event the support arm is inadvertently released. Save time and cost by using it as an arm support for both prepping and traction.

What's Required



#A-40018 (US/EU)*
Simple Clamp
1 Required



#A-21200
Sterile Arm Trap Disposables
Case of 6

What's Optional



#A-30010 (US)*
Accessory Cart



#O-UPBL3S
Lateral Brace
3 Piece Set



#A-60003, #A-60002
Allen® Hug-U-Vac
Lateral Positioner
Standard or Large



#O-LPA
Allen Easy
Irrigation Tower

*Specify Rail Type: US, EU, UK, JP, DEN. See product page for international part numbers.



Lateral Braces #O-UPBL3S **CE**

Extended posts adjust for use on a variety of patients. Stabilizes patients on standard OR tables. For total hip and other procedures requiring optimum lateral stability. Patient Weight Capacity: 400 lbs (181 kg).

- Braces are fully adjustable
- Soft pads provide soft cushioning of bony prominences
- Swivel heads conform to anatomical contours of patient and can be securely locked for precise positioning

What's Included



#O-UPBLR
Single Rectangular Support
2 Included



#O-UPBLC
Single Circular Support
1 Included

What's Required



#A-40040 (US)*
Easy Lock® Blade Clamp
3 Required

What's Optional



#A-30010 (US)**
Accessory Cart

*Specify Rail Type: US, EU, UK, JP.

**Specify Rail Type: US, EU, UK, JP, DEN.

See product page for international part numbers.



Sterile Arm Trap Disposables #A-21200 **CE**



Made of soft plastic mesh, the Allen® Sterile Arm Trap comfortably holds the arm. Arm trap is affixed to patient with CoFlex® NL Self-Adherent Wrap (roll included). Rope loop at the top of the trap allows for easy attachment to many types of traction and suspension devices. (Sold In Cases Of 6)



Integral Straps



Safety Vacuum Valve
(Not Sold Separately)



Waterproof Disposable Slipcover



Allen® Hug-U-Vac® Lateral Positioners

#A-60003, #A-60002

Safe, Comfortable And Secure Lateral Patient Positioning

The Allen Hug-U-Vac Lateral Positioner safely and comfortably holds patients in lateral and supine positions. The Allen Hug-U-Vac Lateral Positioner's integral quick-release straps enable it to attach securely to the rails of standard OR tables.

The Allen Hug-U-Vac Positioner has a secure valve that eliminates the need for continuous suction.

Ideal for use with Urology Procedures, Orthopaedic Procedures, Cardiothoracic Procedures, Neurological Procedures, Thoracotomy Procedures, Plastic Surgery and General Surgery. Can be used for supine positioning in a variety of procedures.

- Enables secure lateral and supine positioning in a variety of procedures
- Integrated axillary pillow
- Lightweight for easy transport, set-up and storage
- Valve location designed for quick access to anesthesia
- No continuous suction required
- Durable vacuum valve with on/off switch and lock
- Disposable slipcovers are waterproof for easy clean-up

#A-60003 Standard

Patient Weight Capacity: 500 lbs (227 kg)
 Device Dimensions: 36" x 32" (91.4 cm x 81.3 cm)

#A-60002 Large

Patient Weight Capacity: 800 lbs (363 kg)
 Device Dimensions: 48" x 35" (121.9 cm x 88.9 cm)

What's Included *Choose One*



#A-60003
 Standard Allen Hug-U-Vac
 Lateral Positioner
 1 Included



#A-60002
 Large Allen Hug-U-Vac
 Lateral Positioner
 1 Included

What's Required *Choose One*



#A-60103
 Standard Allen Hug-U-Vac
 Lateral Disposable Covers
 Case of 12



#A-60102
 Large Allen Hug-U-Vac Lateral
 Disposable Covers
 Case of 12

What's Optional



#O-RSX2
 Allen Large
 Security Strap



#C-008001
 Replacement
 C-Clip Hug-U-Vac



#O-PRSH
 Patient Security Strap Hooks
 4 Required



Active Heel™ Technology
Shown Without Boot Shell



One Boot Accommodates Many
Foot Sizes & Left Or Right Foot



Easy To Use Buckles



Allen® Traction Boot CE

Active Heel™ Technology Provides Superb Security To Help Prevent Foot Slip

Positioning the leg and foot properly during trauma and hip fracture cases is critical to a less stressful surgery and successful outcome. Many hospitals are still using the original boots that may be decades old and require copious amount of tape to help secure the foot. To mitigate these challenges, Allen has introduced the Allen Traction Boot with Active Heel Technology to help prevent foot slip while providing superb security.

With its modular design, you can upgrade your existing trauma tables to the latest technology that has benefits for the patient, surgeon and OR staff.

Active Heel technology utilizes two cushioning pads on the anterior and posterior portions of the leg to provide a secure grip on the entire ankle joint versus the competition which relies on a single point of fixation.

- Active Heel Technology
- Accommodates foot from sizes 5 (female) to 14 (male)
- Universal: One boot fits left or right foot
- Easily retrofits your existing Mizuho OSI, Steris®, Maquet® and Schaerer® traction tables
- Eliminate the need for excessive taping
- Patient Weight Capacity: 500 lbs (227 kg)

Choose Your Traction System

Steris OrthoVision® System



#A-93005
Traction Boot



#A-93006
Clamp for Steris

Mizuho OSI Ovation® & Modular Table Systems



#A-93005
Traction Boot



#A-93007
Clamp for Mizuho OSI

Maquet & Schaerer Systems



#A-93000
Traction Boot



#A-93002
Clamp for Maquet & Schaerer

What's Required



#A-93001
Traction Boot
Disposable
Case of 6



Patient Weight Capacity: 500 lbs (227 kg)

Deluxe Arthroscopic Leg Holder #A-10015

Smooth, one directional locking mechanism enables the caregiver to set rigid fixation with one hand operation. The hinged upper brace accommodates patients while the structurally enhanced design enables the staff to apply pressure both medially and laterally. The ratchet-style securement strap easily adjusts for precise amount of compression. Holds legs up to 35" (89 cm) in circumference.

What's Included



#A-10015
Deluxe Arthroscopic
Leg Holder
1 Included



#R-S4133-V
Leg Holder Disposable Pad
3 Pads Included

What's Required



#A-40022 (US)*
Easy Lock® Socket
1 Required

What's Optional



#O-AWLH
Arthroscopic
Well-Leg Holder



#H-009-00-120
Foam Well-Leg Holder



#A-30010 (US)*
Accessory Cart

*Specify Rail Type: US, EU, UK, JP, DEN. See product page for international part numbers.



Leg Holder Disposable Pads #R-S4133-V

The Leg Holder Disposable Pad is compatible with all Allen® leg holder systems. These pads utilize two special foam materials which are laminated together. The outer pad is a dense, slightly compressible material which allows for high clamping pressure to stabilize the leg. The inner pad is a soft, fully compressible material for gentle, non-abrasive contact with the skin. The leg pad secures with simple Velcro® fasteners. Length is 37.75" (95.9 cm) and width is 3.375" (8.6 cm). (Sold In Cases Of 12)



Arthroscopic Well-Leg Holder #O-AWLH

Easily and safely position the non-affected leg during arthroscopic knee procedures. Help reduce the discomfort and circulatory impairment that can result from the well-leg hanging over the edge of the table. Smooth adjustment and locks securely for precise positioning.

What's Included



#O-AWLH
Arthroscopic
Well-Leg Holder
1 Included



#O-S1007A0.6S
Boot Pad
1 Included

What's Required



#A-40022 (US)*
Easy Lock® Socket
1 Required

What's Optional



#A-30010 (US)*
Accessory Cart

*Specify Rail Type: US, EU, UK, JP, DEN. See product page for international part numbers.



Foam Well-Leg Holder #H-009-00-120

The Foam Well-Leg Holder supports with comfort the non-affected, well-leg during arthroscopic knee procedures, fracture repairs and cast procedures.

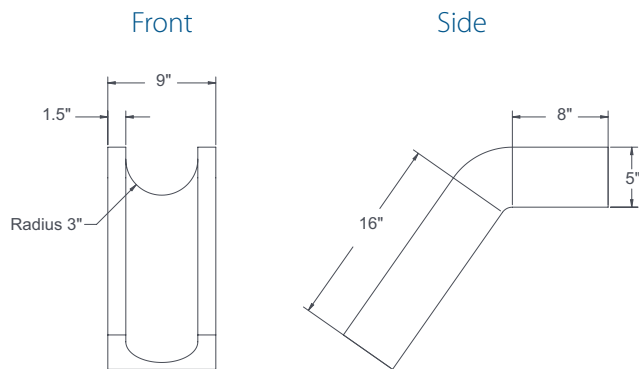



Arthroscopic Stress Post #O-ASP

A levering fulcrum for improved access to the medial compartment of the knee. The 3" x 8" (7.6 cm x 20 cm) post surface is covered with a 1" (2.5 cm) thick, soft pressure management pad for maximum patient safety and comfort.

What's Required



#A-40022 (US)*
Easy Lock® Socket
1 Required

*Specify Rail Type: US, EU, UK, JP, DEN. See product page for international part numbers.



Total Knee Stabilizer #O-TKS

A convenient, stable device to support the flexed leg during total knee procedures. The Total Knee Stabilizer eliminates awkward sandbags and simply mounts to the table rail. The 10" long by 2" diameter (25.4 cm x 5 cm) foot support is covered with a soft, replaceable closed-cell foam pad. The 13" (33 cm) long mounting bar permits vertical height adjustment while the flat .25" x 1" (0.6 cm x 2.5 cm) cross section prevents unwanted rotation. Patient Weight Capacity: 500 lbs (227 kg).

What's Required



A-40040 (US)*
Easy Lock® Blade Clamp
1 Required



#O-TKSP
Replacement
Disposable Pad
1 Required

*Specify Rail Type: US, EU, UK, JP. See product page for international part numbers.



The Prepper Device #O-LPS

Padded cradle comfortably supports patient's leg during prep procedure. Shaft can be rotated to move offset in various positions for convenient access to the leg. Post is 30.5" (77.5 cm) long.

What's Required



A-40022 (US)*
Easy Lock Socket
1 Required



#O-LPSP
Replacement
Disposable Pad
1 Required

*Specify Rail Type: US, EU, UK, JP, DEN. See product page for international part numbers.



Radiolucent & Durable



Rectangular



Hourglass



Minor Procedure

Arm & Hand Tables Comparison

Allen® Medical Systems offers an arm and hand table for every need. All of the tables are radiolucent with outstanding durability, backed by a two-year warranty.

- The carbon fiber, Carbon Lights™ tables utilize a frameless design to avoid perimeter interference during radiographic imaging.
- The Basic tables utilize a phenolic board with a perimeter frame to allow for radiographic imaging.

		#A-30450-C Carbon Lights	#O-AHTR Basic
Rectangular	Weight	5.8 lbs (2.6 kg)	8.8 lbs (4 kg)
	Dimensions	15" x 30.375" (38 cm x 77 cm)	14" x 32" (35.5 cm x 81 cm)
	Material	Carbon Fiber	Phenolic
	Height Adjustable	Yes	Yes
	Legs	Optional	Integral
	Post Type	Round	Blade
	Clamp Type	Universal Clamp	Rail Clamp
	Pad	Sold Separately	2" (5 cm) Standard Pad

		#A-30650-C Carbon Lights	#O-AHTH Basic
Hourglass	Weight	9.2 lbs (4.2 kg)	11 lbs (5 kg)
	Dimensions	16" x 34" (41 cm x 86 cm)	14" x 31" (35.5 cm x 79 cm)
	Material	Carbon Fiber	Phenolic
	Height Adjustable	Yes	Yes
	Legs	Integral	Integral
	Post Type	Round	Blade
	Clamp Type	Integral (US and EU)	Rail Clamp
	Pad	Sold Separately	2" (5 cm) Standard Pad

		#A-30410-C Carbon Lights	#O-AHMPT Basic
Minor Procedure	Weight	3.4 lbs (1.5 kg)	7.4 lbs (3.4 kg)
	Dimensions	15" x 24" (38 cm x 61 cm)	14" x 26" (35.5 cm x 66 cm)
	Material	Carbon Fiber	Phenolic
	Height Adjustable	Yes	Yes
	Legs	Legless	Legless
	Post Type	Round	Blade
	Clamp Type	Universal Clamp	Rail Clamp
	Pad	Sold Separately	2" (5 cm) Standard Pad



Basic Rectangular Table #O-AHTR

The Basic Rectangular Table features a telescoping leg that can be easily moved in various positions to provide additional support. The table permits superior access to the surgical site and it attaches to a standard OR table. Includes 1.5" (3.8 cm) pad, for use with 2" (5 cm) OR table pads.

- Weight: 8.8 lbs (4 kg)
- Table Dimensions: 14" x 32" (35.5 cm x 81 cm)
- Patient Weight Capacity: 400 lbs (181 kg)

Outer Rail Requires US Rail Clamp for Accessories

What's Included



#O-AHTR
Basic Rectangular Table
1 Included



#O-AHTP
1.5" (3.8 cm) Pad
1 Included

What's Required



A-40040 (US)*
Easy Lock® Blade Clamp
2 Required

*Specify Rail Type: US, EU, UK, JP. See product page for international part numbers.



Carbon Lights™ Rectangular Table

#A-30450-C

The perfect answer for arm and hand procedures. Use without the removable leg when access is paramount. Simply add the optional leg for those procedures requiring additional stability. Attaches via two round .625" (1.6 cm) posts. Call Customer Service to inquire about clamps to fit alternate rail sizes. Note: Pad sold separately.

- Carbon Fiber
- Weight: Approx. 5.8 lbs (2.6 kg)
- Table Dimensions: 15" x 30.375" (38 cm x 77 cm)
- Patient Weight Capacity: 400 lbs (181 kg)

Table With Leg

What's Required *Choose One Pad*



#A-40015 (US Only)
Universal Accessory Clamp
2 Required



#A-30300-Pad-1
1" (2.5 cm) Pad
1 Required

OR



#A-30300-Pad
2" (5 cm) Pad
1 Required

What's Optional



#A-20750
Schlein Hand Positioner
Includes Rail Attachment



#A-30450-LEG
Optional Leg



Basic Hourglass Table #O-AHTH

The Basic Hourglass Table features a telescoping leg that can be easily placed in various positions to provide additional support. The table provides additional surface for surgeon's elbows or instrumentation. Attaches to a standard OR table and includes a 1.5" (3.8 cm) pad, for use with 2" (5 cm) OR table pads.

- Weight: 11 lbs (5 kg)
- Table Dimensions: 31.375" x 23" *Max* / 14.75" *Min* (79.7 x 58.4 cm *Max* / 37.5 cm *Min*)
- Patient Weight Capacity: 400 lbs (181 kg)

Outer Rail Requires US Rail Clamp for Accessories

What's Included



#O-AHTH
Basic Hourglass Table
1 Included



#O-AHTHP1.5
1.5" (3.8 cm) Pad
1 Included

What's Required *Choose One*



A-40040 (US)*
Easy Lock® Blade Clamp
2 Required



#O-RC2 (US)**
Rail Clamp
2 Required

*Specify Rail Type: US, EU, UK, JP.

**Specify Rail Type: US, EU, UK, JP, DEN, SWISS.

See product page for international part numbers.



Carbon Lights™ Hourglass Table #A-30650-C

This full-sized table provides stability and is light enough for easy transport. The adjustable support leg provides additional stability and can be tucked under for easy access. The integral mounting clamps allow vertical adjustment to align with pads on X-ray tops. Note: Pad sold separately.

- Carbon Fiber
- Fits EU & US Rails Only
- Weight: Approx. 9.2 lbs (4.2 kg)
- Table Dimensions: 34" x 16" (26" at end) 86 cm x 41 cm (66 cm at end)
- Patient Weight Capacity: 400 lbs (181 kg)

What's Included



#A-30650-C
Carbon Lights
Hourglass Table
1 Included



#A-30650ER
Elbow Rest
1 Included

What's Required *Choose One*



#A-30502-1-B*
Pad Set for A-30650-C
1" (2.5 cm)
1 Required



#A-30502-B*
Pad Set for A-30650-C
2" (5 cm)
1 Required



Integral Clamps

What's Optional



#A-30650-Clamp
Replacement Clamp



#A-20750
Schlein Hand Positioner
Includes Rail Attachment



#A-30530-1
Elbow Rest Pads

*Pad sets include table pad and two elbow rest pads



Table With Leg

Carbon Lights™ Minor Procedures Table

#A-30410-C

This small and ultra lightweight table works well for procedures such as carpal tunnel releases and AV fistulas. Has two round .625" (1.6 cm) posts. Note: Pad sold separately.

- Carbon Fiber
- Weight: Approx. 3.4 lbs (1.5 kg)
- Table Dimensions: 24" x 15" (61 cm x 38 cm)
- Patient Weight Capacity: 400 lbs (181 kg)

What's Required *Choose One Pad & One Clamp*

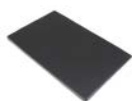

OR



#A-30410-Pad1
1" (2.5 cm) Pad
1 Required

#A-30410-Pad
2" (5 cm) Pad
1 Required

#A-40015 (US Only)
Universal Accessory Clamp
2 Required

What's Optional



#A-20750
Schlein Hand Positioner
Includes Rail Attachment



#A-30450-LEG
Optional Leg



Outer Rail Requires US Rail Clamp for Accessories

Basic Carpa® Table #O-AHMPT

The Carpa Table is a legless design with a rigid self-bracing frame. It has a 14" x 26" (35.5 x 66 cm) radiolucent top for maximum access and weighs 7.4 lbs (3.4 kg). The perfect choice for carpal tunnel procedures. Easy drop-in rail attachment. Includes 1.5" (3.8 cm) pad, for use with 2" (5 cm) OR table pads.

- Weight: 7.4 lbs (3.4 kg)
- Table Dimensions: 14" x 26" (35.5 cm x 66 cm)
- Patient Weight Capacity: 400 lbs (181 kg)

What's Included



#O-AHMPT
Basic Carpa Table
1 Included



#O-AHMPTP
1.5" (3.8 cm) Pad
1 Included

What's Required



#A-40040 (US)*
Easy Lock® Blade Clamp
2 Required

*Specify Rail Type: US, EU, UK, JP. See product page for international part numbers.



The Equalizer #R-734-05

Used when three or more digits are placed in traction, The Equalizer distributes the weight of the arm equally between each digit. This stainless steel chain and pulley system is fully autoclavable and comes with an attaching clip. The Equalizer can also be used with the Wrist Fracture System and Weightless Shoulder Suspension System.

Required



Sterile Mesh Finger Trap Disposables
See page 96

What's Optional



#O-LPA
Allen® Easy Irrigation Tower



#R-734-10
Wrist Arthroscopy System



Wrist Arthroscopy System #R-734-10

The table mounted Wrist Arthroscopy System is a stable platform and ideal for distraction of the hand, wrist, forearm and elbow. Support extensions mounted off of the tower provide wrist flexion and extension, radial and ulnar deviation and allow for dorsal and volar approaches. Autoclavable.

- Tension adjustments up to 40 lbs (18 kg)
- Allen self-equalizing Finger Traps distribute tension evenly
- Wrist stabilizer provides wrist flexion and extension
- Counter traction device eliminates need for hanging weights

What's Included



#R-734-10
Wrist Arthroscopy System
1 Included

What's Required



#A-40018 (US/EU)*
Simple Clamp
1 Required



Sterile Mesh Finger Trap Disposables
See page 96

What's Optional



#O-LPA
Allen Easy Irrigation Tower

*Specify Rail Type: US/EU, UK, DEN. See product page for INTL part numbers.

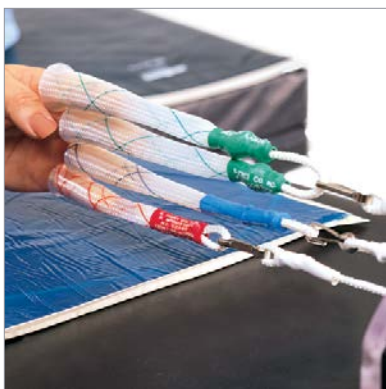

Sterile Mesh Finger Trap Disposables €

Sterile single or double traps. Disposable, for single use only. Five color-coded sizes: Pediatric, Small, Medium, Large, Extra Large.

Sterile Starter Kit

Comes with eight finger traps in four sizes (Extra Large, Large, Medium, Small - two each)

#R-30522-999 Double Starter Kit

#R-30522-888 Single Starter Kit



Pediatric Trap

Cases - 8 Per Case

Singles

- #A-30522-8 Single, Extra Large
- #A-30522-2 Single, Large
- #A-30522-4 Single, Medium
- #A-30522-5 Single, Small
- #A-30522-9 Single, Pediatric Trap

Doubles

- #A-30522-7 Double, Extra Large
- #A-30522-1 Double, Large
- #A-30522-3 Double, Medium
- #A-30522-6 Double, Small



Finger Trap Sizing Kit #R-50522-1 €

Facilitates size selection prior to opening sterile finger traps.



Schlein Hand Positioner #A-20750 €

Supports multiple hand positions. Innovative cleat system can be used with or without weights. Autoclavable.

What's Included



#A-20750
Schlein Hand Positioner
1 Included



Rail Attachment
1 Included
Not sold separately.

What's Required



Sterile Mesh Finger
Trap Disposables
See page 96



General



No Lifting Required



Easy Transfer To & From
Fowler's Position



Single-Use Disposables



Long, Wide Board
Weighs only 7 lbs (3.2 kg)



Long, Narrow Board
Weighs only 6.3 lbs (2.8 kg)



Short, Narrow Board
Weighs only 5 lbs (2.3 kg)

Patient Transfer Board #A-83005, #A-83000, #A-83001

Roller-Free Roller Board – Better For Patients, Easier On Nurses And Inexpensive

- **Comfortable:** Soft core with no hard metal rollers
- **Lightweight:** No lifting required, even with your heaviest patients
- **No Special Training Requirements:** Uses same or similar transfer technique
- **Fowler’s Position Transfer:** Long board allows for transfer in seated position
- **Foldable:** Long board folds for easy storage and set-up
- **Straps:** Carry this lightweight device on your shoulder and keep your hands free
- **Resilient and Sturdy:** Durable material protects against end cap breakage
- **Patient Weight Capacity:** 500 lbs (227 kg)

- #A-83005 Long, Narrow Patient Transfer Board
71.5" x 16.5" (180 cm x 42 cm)
- #A-83000 Long, Wide Patient Transfer Board
71.5" x 20.5" (180 cm x 52 cm)
- #A-83001 Short, Narrow Patient Transfer Board
40" x 16.5" (100 cm x 42 cm)

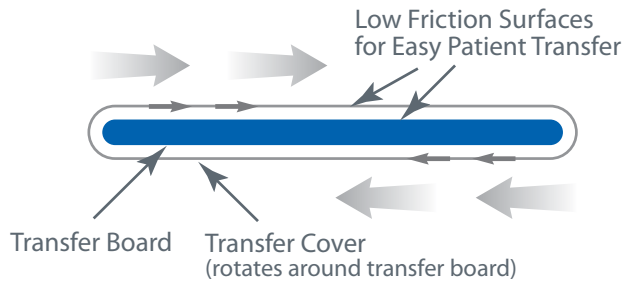

What’s Optional



#A-83017
Narrow Board
Replacement Strap



#A-83018
Wide Board
Replacement Strap



#A-83002*
Disposable Covers
23" wide x 38" long
(58.4 cm wide x 96.5 cm long)
Case of 50



#A-83015
Narrow Board
Replacement Cap



#A-83016
Wide Board
Replacement Cap

*Fits all Allen® transfer boards

Allen® Clamps Comparison

Allen sells a variety of clamps for use with OR table accessories.

This chart provides a snapshot of Allen clamps categorized by feature, function and country rail type for selection purposes.

		Country Rails:						Use With:		Attach Clamp:			
		US = .375" x 1.125"	EU = 10 x 25 mm	UK = .25" x 1.25" (6.35 x 31.75 mm)	Denyer = .25" x 1.5" (6.35 x 38.1 mm)	Swiss = 10 x 30 mm	Japanese = 9 x 32 mm	Round Post	Rectangular Blade	Anywhere On Table Rail	Anywhere Between Rail Standoffs	At Table Rail Ends, and Table Rail Notches	CE
ROTATING CLAMPS	 Easy Lock® Socket The premium clamp - instantly locks into place anywhere on the rail.	•	•	•	•		•	•		•			•
	 Autoclavable Clamp Designed for use in the sterile field.	•	•			•	•	•		•	•		•
	 Tri-Clamp® Device Adjust the accessory while keeping the clamp locked securely on the rail.	•	•					•	•		•		
FIXED CLAMPS	 Easy Lock Blade Clamp The premium clamp - instantly locks into place anywhere on the rail.	•	•	•			•		•	•			•
	 Rail Clamp Basic design allows for securement of blade products.	•	•	•	•	•	•		•			•	•
	 Simple Clamp Can be sterilized. Simple Clamp can secure over the surgical drape.	•	•	•	•			•				•	•
	 Universal Accessory Clamp Low profile knob is unobtrusive, can accommodate post and blades.	•						•	•		•		



For Round Posts

Easy Lock® Socket #A-40022

Quite Possibly the Easiest Accessory Clamp In The World

No need to look for table notches when attaching the Easy Lock Socket. Attach the clamp anywhere on a standard OR table rail. Accepts any round post up to .6875" (1.8 cm). Quick and easy pull-to-release lever. Lithotomy wheel for accessory angle adjustments. Patient Weight Capacity: 800 lbs (363 kg).

Specify Rail Type

US	#A-40022	Japan	#A-40030
EU	#A-40023	Denyer	#A-40025
UK	#A-40024		



For Rectangular Blades

Easy Lock® Blade Clamp #A-40040

Quite Possibly the Easiest Blade Clamp In The World

No need to look for table notches when attaching the Easy Lock Blade Clamp. Attach the clamp anywhere on a standard OR table rail. Accepts all 1" x .25" (2.5 cm x 0.6 cm) accessories with flat mounting blades. Quick and easy pull-to-release lever. Patient Weight Capacity: 800 lbs (363 kg).

Specify Rail Type

US	#A-40040	UK	#A-40042
EU	#A-40041	Japan	#A-40043





For Round Posts

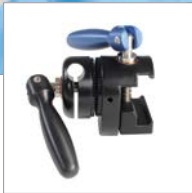

Autoclavable Clamp #A-92002

Allen's Autoclavable clamp is fully autoclavable and is designed for use in the sterile field. It can attach to the rail over multiple drapes and accepts accessories with a .625" (1.6 cm) wide post. The clamp provides 360° rotation for optimal positioning. For use with Allen® Arm Positioner (#A-92000) only. Patient Weight Capacity: 500 lbs (227 kg).

US/EU/Swiss/Japan #A-92002



For Round Posts
For Rectangular Blades

Universal Accessory Clamp #A-40015

Unique, basic clamp that fits both .5" to .625" (1.3 cm to 1.6 cm) table accessories with round posts as well as blade-type posts 1" x .25" (2.5 cm x 0.6 cm). Attach the clamp anywhere on a standard OR table rail between rail standoffs. Not recommended for use with stirrups. Patient Weight Capacity: 350 lbs (159 kg).

US Only #A-40015



For Round Posts
For Rectangular Blades

Tri-Clamp® Device #A-40016

Very versatile clamp with three independent adjustments for lithotomy, abduction and rail securement. Attach the clamp anywhere on a standard OR table rail between rail standoffs. Accepts .5" to .625" (1.3 cm to 1.6 cm) round and 1" x .25" (2.5 cm x 0.6 cm) flat accessories. Patient Weight Capacity: 350 lbs (159 kg).

US Only #A-40016



Simple Clamp #A-40018

Innovative design allows placement under/over drapes. Durable aluminum and stainless steel construction. Attach the clamp anywhere on a standard OR table rail between rail standoffs. Holds all .5" to .625" (1.3 cm to 1.6 cm) diameter accessories. Patient Weight Capacity: 500 lbs (227 kg).

Specify Rail Type

US/EU #A-40018
UK #A-40018-UK

For Round Posts



Rail Clamp #O-RC2

Securely locks accessories with flat mounting blades anywhere along the table side rail. Attaches at standard OR table rail ends or rail notches. Perfect for tabletop extensions and knee/foot board applications. Strong and lightweight replacements for original rail locks. Accessories can be mounted either vertically or horizontally. Reduces the "free play" associated with standard clamps. Accepts 1" x .25" (2.5 cm x 0.6 cm) flat accessories. Patient Weight Capacity: 720 lbs (327 kg).

Specify Rail Type

US #O-RC2
EU/UK #O-RC2XUK
Japan #O-RC29X32MM
Denyer #O-RC2XD

For Rectangular Blades



Accessory Cart #A-30010

The Accessory Cart provides convenient storage for most of your surgical table accessories. Six rails and a deep bin afford plenty of storing space. Optional accessory hooks allow quick and easy storage. Weighted base makes cart tip-resistant and reduces potential vibration during transport. Polymer base is dent-resistant. Heavy-duty casters roll smoothly. Two casters lock for safe and easy loading, unloading and storage.



What's Included



Specify Rail Type
 #A-30011 (US)
 #A-30011E (EU)
 #A-30011J (Japan)
 2 Included

The Accessory Hook allows for faster product storage on our Accessory Cart. Coated prongs help protect stored product from developing scratches. Easy Lock® design makes attachment and detachment easy.

Specify Rail Type

US	#A-30010	UK	#A-30010UK
EU	#A-30010E	Japan	#A-30010J

Protect Your Investment



Stirrup Cart #A-30015

A great way to store and protect your investment, this strong and lightweight cart holds and transports your stirrups or legholders. Compact and state-of-the-art, the cart will hold any Allen stirrup. The sturdy molded four-caster polymer base is dent-resistant. The deep storage bin is a great place to store clamps and pads securely. Two casters lock for safe and easy loading, unloading and storage.



Two different size hooks allow this storage cart to hold a variety of stirrups. Hold up to a .75" (1.9 cm) rod on the smaller hook and up to a 1" (2.5 cm) on the larger hook.



Allen® Beach Chair Cart #A-90100

The perfect companion, the Allen Beach Chair Cart conveniently stores the Allen Beach Chair and all of its accessories. The Beach Chair rests securely on sturdy rails at user height to help reduce potential back strain. Optional accessory hooks allow quick and easy storage for larger accessories. Deep bin affords plenty of extra storing space. Weighted base makes cart tip-resistant and reduces potential vibration during transport. Polymer base is dent-resistant. Heavy-duty casters roll smoothly. Two casters lock for safe and easy loading, unloading and storage.



What's Optional



Specify Rail Type
 #A-30011 (US)
 #A-30011E (EU)
 #A-30011J (Japan)

The Accessory Hook allows for faster product storage on our Accessory Cart. Coated prongs help protect stored product from developing scratches. Easy Lock® design makes attachment and detachment easy.

Specify Rail Type

US	#A-90100	Japan	#A-90100J
EU	#A-90100E		



Bow® Frame Cart #A-70815

The Bow Frame Cart stores all of the accessories used with the frame, including the head positioner and arm supports. The Bow Frame stores securely in the deep bin of the cart. The cart's weighted base makes it tip-resistant and reduces potential vibration during transport. Polymer base is dent-resistant. Heavy-duty casters roll smoothly. Two casters lock for safe and easier loading, unloading and storage.



Specify Rail Type

US	#A-70815	UK	#A-70815-UK
EU	#A-70815-EU	Japan	#A-70815-JP



Easy Rack #O-MR2

The Easy Rack will provide convenient storage for your stirrups, armboards, clamps, straps and other table accessories. Constructed with dent-resistant polymer. Specially designed hooks will store stirrups and can be placed onto rack just like they came off the table. No need to readjust to fit on rack. Unique key slots accept .25" x 1" (0.6 cm x 2.5 cm) flat and .625" (1.6 cm) round mounting posts without the need for clamps. Requires appropriate wall fasteners (not included).

Specify Rail Type

US #O-MR2
Japan #O-MR2J
Denyer #O-MR2D



Easy Armboard With Trigger #O-ABSLT

With the trigger design, simply pull the radiolucent release mechanism for full articulation and release it to lock. A spring lever accessible from both sides securely locks the armboard to the rail. Armboard measures 26" x 5.5" (66 x 14 cm). The pad width measures 6" (15.2 cm). Patient Weight Capacity: 400 lbs (181 kg). Pad not included.

What's Required *Choose One*



#O-AMA96X2.0S
 Clamshell Armboard
 2" (5 cm) Pad
 1 Required



#O-AMA96X3.0S
 Clamshell Armboard
 3" (7.6 cm) Pad
 1 Required

What's Optional



#(multiple)
 Polymer Gel Pads
Call Sales Dept. for part numbers



#(multiple)
 Pressure Management Pads
Call Sales Dept. for part numbers

Specify Rail Type

US #O-ABSLT
EU #O-ABSLTE
UK #O-ABSLTUK

Note: All armboards are radiolucent



Easy Armboard Lift-to-Position #O-ABSL

Lift the end of the board and rotate to the desired position. The patient's arm weight locks the board in place when lowered. A spring lever securely locks the armboard to the rail. Armboard measures 26" x 5.5" (66 x 14 cm). Note: Japanese version is 22"x 5.5" (56 x 14 cm). The pad width measures 6" (15.25 cm). Patient Weight Capacity: 400 lbs (181 kg).

Specify Rail Type

- | | | | |
|-----------|-----------|---------------|------------|
| US | #O-ABSL | Japan | #O-ABSLJ22 |
| EU | #O-ABSLE | Denyer | #O-ABSLD |
| UK | #O-ABSLUK | | |



What's Required



#O-AMA96X2.05
Clamshell Armboard
2" (5 cm) Pad
1 Required



#O-AMA96X3.05
Clamshell Armboard
3" (7.6 cm) Pad
1 Required

What's Optional



#(multiple)
Polymer Gel Pads
Call Sales Dept. for part numbers



#(multiple)
Pressure Management Pads
Call Sales Dept. for part numbers

Note: All armboards are radiolucent



Lateral Positioning



Seated Positioning



The Wrap-Around Pad Provides Protection and Stability

LPS Arm Support #A-90002

Safely And Easily Positions Patients In Lateral, Prone And Seated Orientations

Allows for effective positioning of arms to help prevent potential patient injury. The malleable hand rest enables surgeon to place patient's hand in any desired orientation. Patient Weight Capacity: 500 lbs (227 kg).

What's Included



#A-90002
LPS Arm Support
1 Included



#A-AMA74
LPS Arm Support Pad
1 Included

What's Required



#A-40022 (US)*
Easy Lock® Socket
1 Required

*Specify Rail Type: US, EU, UK, JP, DEN. See product page for international part numbers.



Multi-Task Armboard #O-ABMT

Provides arm support for lateral, chair, prone and neuro park bench positions. Lockable ball socket combined with 6" (15.2 cm) of horizontal travel permits a wide range of positioning flexibility. Patient Weight Capacity: 500 lbs (227 kg). See page 76 for positioning illustrations.

What's Required *Choose One Pad*



#A-40022 (US)*
Easy Lock® Socket
1 Required



#O-AMA97X1.0S
Clamshell Armboard
1" (2.5 cm) Pad
1 Required

OR



#O-AMA12X1.0S
Standard Armboard
1" (2.5 cm) Pad
1 Required

*Specify Rail Type: US, EU, UK, JP, DEN. See product page for international part numbers.



Shown in Use with
Armboard Pad

Arm Shield #O-AS

Slides under back section pad to protect arms and keep them from falling off table. The radiolucent Arm Shield provides a comfortable safe platform for surgical staff to lean on without harming patient or dislodging IV's. Soft flexible pad provides comfortable patient cushion reducing risk of pressure related injury. Armboard Pad not included. Dimensions: 15.75" wide by 7" high (40 cm x 18 cm).

What's Included



#O-AS
Arm Shield
1 Included



#O-AMA53X0.6S
Arm Shield Pad
1 Included

What's Required



#(multiple)
Pressure Management Pads
See page 123
Call Sales Dept. for
part numbers



Comfort Mat #O-CM

Step Onto Comfort And Feel The Difference

The Comfort Mat is a closed-cell, absorbent-resistant foam which helps reduce fatigue, pain and discomfort associated with standing for long periods of time. The beveled, low profile edges facilitate easy access to the surface. The surface measures 20" x 33" (51 cm x 84 cm), but is also available in custom sizes. This non-slip surface is chemical resistant. Custom mats are priced per square inch.



Anesthesia Screen With Wings #O-ASLW

Single point mount provides easy attachment and removal. Adjusts vertically from 22" to 30" (56 cm to 76 cm) and rotates horizontally for added flexibility and convenient patient access. Folds flat for easy storage. The .625" (1.6 cm) mounting post fits standard clamps. Adjustable drape support wings pivot in all planes and lock with a simple twist.

What's Required



#A-40022 (US)*
Easy Lock® Socket
1 Required

*Specify Rail Type: US, EU, UK, JP, DEN. See product page for international part numbers.



Flexible Anesthesia Screen #O-FAS

This malleable screen conforms to any shape you desire. The plastic encased metal link construction remains stable as shaped. Has .625" (1.6 cm) post.

What's Required



#A-40022 (US)*
Easy Lock® Socket
1 Required

*Specify Rail Type: US, EU, UK, JP, DEN. See product page for international part numbers.



Needle Trier™ Device #A-75000

Help protect your staff from sharps injuries with the Allen® Needle Trier. This suture needle retrieval system has a large magnetic surface to easily pick up ferrous needles and sharps as small as .006" (.15 mm) diameter. Our unique design allows this magnetic sweeper to reach under the surgical table and other hard-to-reach places. The lightweight aluminum is easy to use and store. The long handle, more than 3' (1 meter), means you don't need to bend over to find lost sharps.

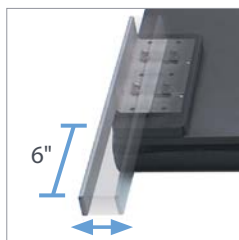

Post Moves In and Out to Accommodate Various Table Widths

Adjustable Footboard #O-AFB

Adjustable width accommodates outside rail dimensions of 21" to 23.25" (53 cm to 59 cm). Attaches horizontally as a table extension to accommodate taller patients or vertically as a foot support. Easily mounts to the foot section side rails of a standard OR table. Radiolucent construction permits unhindered imaging. Includes 2" (5 cm) premium pressure management pad to reduce heel pressure. Patient Weight Capacity: 500 lbs (227 kg).

What's Included



#O-AFB
Adjustable Footboard
1 Included



#O-AMA122X2.0R
Adjustable Footboard Pad
1 Included

What's Required



#O-RC2 (US)*
Rail Clamp

*Specify Rail Type: US, EU/UK, JP, DEN, SWISS. See product page for international part numbers.

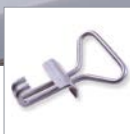

#O-PRSH Hooks



Portable and Easy to Use.
No Clamps Required.

Security Straps #O-PRSLH, #O-RSX2

Loops around the side rail for simple table attachment and adjusts easily with buckles. Patient Weight Capacity: 500 lbs (227 kg).

#O-PRSLH Medium Security Strap (without hooks)

- Soft padded center section is .5" (1.3 cm) thick, 5" (12.7 cm) wide, 18" (46 cm) long.
- Strap is adjustable from 18" to 45" (46 cm to 114 cm)

#O-RSX2 Large Security Strap (without hooks)

- Soft padded center section is .5" (1.3 cm) thick, 6" (15.2 cm) wide, 24" (61 cm) long.
- Strap is adjustable from 24" to 80" (61 cm to 203 cm)

What's Optional



#O-PRSH
Patient Security Strap Hooks
2 Required



Frogger™ Pad #H-009-00-100 CE

Use the Frogger Pad to position patient's legs during saphenous vein harvesting. The cushion splays legs slightly so that knees tilt outward—providing easier access to the surgical site as well as a stable platform on which to operate. Useful for both minimally invasive endoscopic procedures as well as for the traditional groin-to-ankle incision.

The cover is made with 4-way stretch material. Inside construction includes a top layer of conforming foam with soft yet supportive foam beneath.

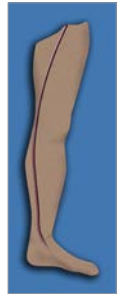

Greater Saphenous Vein



Extremity Positioner #H-009-00-110

The Extremity Positioner is used most frequently for prepping extremity surgical sites. It is also used for positioning the leg for foot and ankle procedures.



Foam Well-Leg Holder #H-009-00-120

The Foam Well-Leg Holder supports with comfort the non-affected, well-leg during arthroscopic knee procedures, fracture repairs and cast procedures.

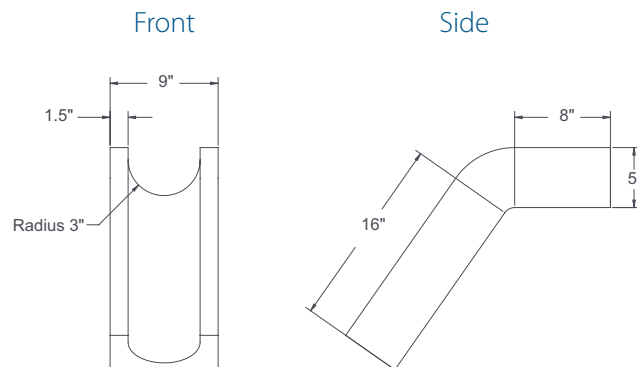

Bariatric Product Offering



Ultrafins® Stirrups #O-UFAS ☼

The Ultrafins Stirrup is the latest in bariatric lithotomy positioning. This stirrup features a roomier boot for larger calves. Piston technology helps to position heavy legs with less effort. Includes clamshell-type boot pads. Patient Weight Capacity: 800 lbs (363 kg).

What's Included



#O-UFAS
Ultrafins Stirrups
1 Pair Included



#O-AMA65S0.6S
Ultrafins Clamshell Pad
1 Pair Included

What's Required



#A-40040 (US)*
Easy Lock® Blade Clamp
2 Required

*Specify Rail Type: US, EU, UK, JP. See product page for international part numbers.



Bariatric Nissen Thigh Straps #A-80400 ☼

Bariatric Nissen Thigh Straps offer the support larger patients need during steep reverse Trendelenburg positioning. The pad is wide and long to offer comfortable support. Integral clamps attach to rail securely. Patient Weight Capacity: 1,000 lbs (454 kg).

- Pad is 7" (18 cm) wide and 31" (79 cm) long
- Straps are adjustable in usable-length up to 70" (179 cm)

Specify Rail Type

US #A-80400
EU #A-80400E
UK #A-80400UK

Note: Nissen Thigh Straps are Sold in Pairs



Allen® Hug-U-Vac® Large Steep Trend Positioner #A-60005 ☼

The Allen Hug-U-Vac Steep Trend Positioners are Vacuum Activated Positioning Systems that have been specifically designed to hold patients safely during procedures requiring the steep Trendelenburg position while maximizing surgical and anesthesia access to the patient. The Allen Hug-U-Vac positioner has integral quick-release straps that enable it to attach securely to the rails of standard OR tables. The Allen Hug-U-Vac Steep Trend Positioners unique pliable design enables it to inflate and deflate evenly to fit the patient's body. Patient Weight Capacity: 500 lbs (227 kg).

See page 61 for more information on the Large Steep Trend Positioner.

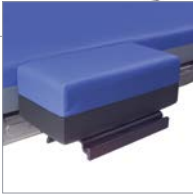
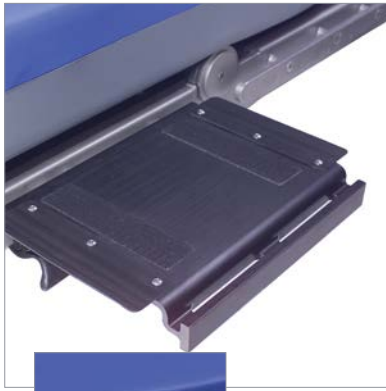

Fits US Rails Only,
Depending on Table
Limitations

8" Bariatric Table Width Extender

Bariatric Table Width Extender (TWE) increases the support surface of your surgical table by 8" (20 cm) on each side.

- Attaches to the back, seat and leg sections to create extra width needed by larger, heavier patients.
- Full length extender provides ample support for patients.
- Shorter extender provides space on table rail for weight-bearing accessories (stirrups, thigh retractors, armboards, etc.)
- Patient Weight Capacity: 1,000 lbs (454 kg)

What's Required



#(multiple)
Bariatric Table Width Extender Pads
Available in thicknesses of 2" to 7" (5 cm to 18 cm).
Call Sales Dept. for part numbers

#A-80100

8" x 15" (20 cm x 38 cm)

#A-80150

8" x 11" (20 cm x 28 cm) *shown*



Fits US Rails Only

Bariatric Armboard #A-80200

Our Bariatric Armboard is exactly what you need to help secure larger patients. It is easy to mount and easy to use. The spring lever mounting mechanism, accessible from both sides, securely locks the armboard to the rail. The trigger adjustment offers easy articulation as well as fine increments of adjustment to allow for precise positioning. The tooth-free mechanism is engineered to withstand the rigors of the operating room. Purchase contoured armboard surfaces or our unique inclining surface that does not require extra padding to prevent hyper-extending the arm. Armboard is 8" (20 cm) wide and 26" (66 cm) long. Patient Weight Capacity: 1,000 lbs (454 kg).



Surfaces, Pads & Gels

Allen® Perioperative Surfaces & Pads

Allen Medical offers a variety of pads to fit your standard OR tables and armboards. Allen has over 10 years of experience in the area of pressure management. The engineered foams in our OR table pads were cutting edge when first developed and our products have remained at the forefront of technological innovation ever since – with new radiolucent foam formulations and multi-density pad layouts.

Why OR Table Surfaces Matter...

Healthcare professionals are implementing new prevention initiatives and standards for pressure injury prevention.

From a surge in recent research pertaining to pressure injuries to the Medicare Guidelines that took effect in October 2008, the issue of hospital-acquired pressure injuries is a popular topic for many healthcare professionals. Additionally, professional organizations like AORN and NPUAP are critical to advancing awareness of the issue through their release of new standards and practices to help prevent and treat hospital-acquired pressure injuries.

- Static surfaces increase surface support areas and decrease pressures and shear forces.⁴
- Old-fashioned “egg crate” mattresses offer no advantage.⁴
- A study of 1,128 surgical patients, revealed the incidence of nosocomial pressure ulcers related to the operating room (OR) was 23%.⁵
- A multi-layer pressure redistribution surface was found to be statistically significant in reducing pressure ulcer incidence when compared with the “Standard” OR table pad.⁵
- Surgical patients account for 34-42% of all hospital-acquired pressure ulcers.²
- In an experiment involving 323 patients between 2000 and 2004, 38% of patients who had the standard pad during surgery developed the sores. But only 7% of patients who had the pressure-relieving pad developed pressure ulcers.⁷
- Various studies have suggested that pressure ulcers may occur within a 1 to 4 hour time frame, well within the range of current surgical procedures.⁶

Pressure Injury Prevalence

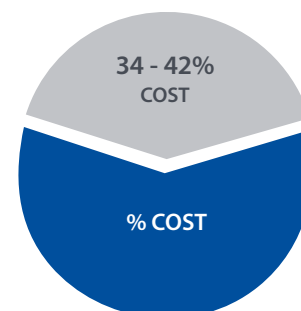

Cost Of OR Acquired Pressure Ulcers²

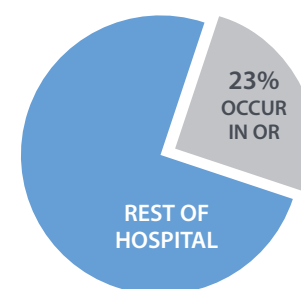

Hospital Acquired Pressure Ulcers²

1. Aronovitch SA. Intraoperatively acquired pressure ulcer prevalence: a national study. *J Wound Ostomy Continence Nurs.* 1999;26(3):130-136.

2. Beckrich K, Aronovitch SA. Hospital-acquired pressure ulcers: a comparison of costs in medical vs. surgical patients. *Nurs Econ.* 1999;17(5):263-71.

3. Stotts N. Predicting pressure ulcer development in surgical patients. *Heart and Lung.* 1988;17(6):641-6.

4. Pressure Ulcers (Pressure sores; Bedsores; Decubitus Ulcers; Decubiti). *The Merck Manuals, Online Medical Library.* Available at: <http://www.merck.com/mmpe/sec10/ch126/ch126a.html> (accessed Sept. 2015).

5. Lummus AC. Perioperative Pressure Ulcer Assessment and Prevention: Efficacy Study of a Multi-Layer Pressure Relief Pad in the Operating Room (OR). University of Tennessee Health Science Center. 2004.

6. Baron S, MacFarlane G. Reducing Pressure Ulcer Risk In The Operating Room. White Paper. 2009. Allen Medical Systems, D-770444-A2.

7. Scott-Williams S. Perioperative Pressure Ulcer Prevention Program (PPUPP): An innovative effort to prevent pressure ulcers in surgical patients. *American Academy of Nursing.* <http://www.aannet.org/edge-runners-perioperative-pressure-ulcer-prevention-program> (accessed Sept. 2015).

Allen® Surfaces Technology

No Single Foam Provides Effective Pressure Management...



Allen Uses 4 Foams For Effective Pressure Management

Optimal pressure management requires a pad that is effective in four main support functions: 1-conforming to the patient's body, 2-providing proper support, 3-prohibiting bony prominences from bottoming out and 4-evening out irregularities and gaps in the table surface.

No single foam can support all four functions effectively. Listed below are the 4 foams Allen has proven effective to provide optimal pressure management in a single pad.

"Neither the position of the patient, nor the time spent on the OR bed can be altered easily during surgery."

Varying the type of pressure-reducing mattress may be the most appropriate method to prevent pressure ulcers during the perioperative period."

- Alexander's Care of the Patient in Surgery, 13th Edition



1
Memory Foam
Conforming layer



2
Low Density Elastic Foam
Support layer



3
High Density Elastic Foam
Anti-bottoming layer



4
Closed Cell Foam
Diaphragm layer

Allen Perioperative Surfaces: Pressure Maps

Model: Female
Weight: 117 lbs (53 kg)
Height: 63" (160 cm)

Astrus Elite



Deluxe

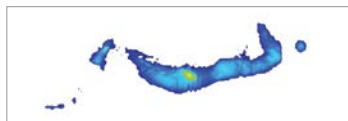

Standard

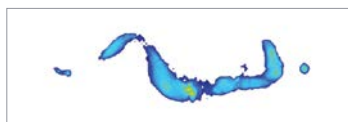

Model: Male
Weight: 180 lbs (82 kg)
Height: 68" (173 cm)

Astrus Elite



Deluxe

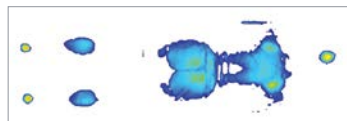

Standard



Model: Male
Weight: 300 lbs (136 kg)
Height: 73" (185 cm)

Astrus Elite

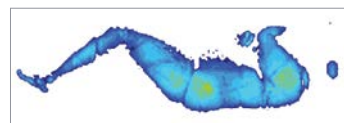

Deluxe

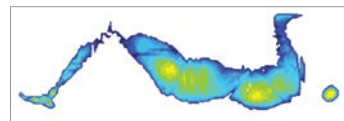

Standard

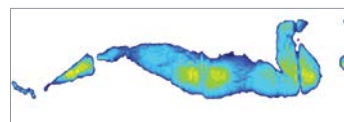

The Allen® Pressure Management Solution

Allen Pads Contain Multiple Foam Layers For Optimal Pressure Management



Astrus Elite™ Surface

Effective Pressure Management Our Astrus Elite Surface has a 4-layer foam composite construction that protects patients in four ways. A top layer of memory foam conforms to the patient while the underlying foam layers support the patient’s weight and prevent bottoming out.

Astrus Elite Cross-Section

Allen Surfaces Selector Chart

		Foam Layers				Benefits				Pad Thickness						
		Conforming Layer	Support Layer	Anti-bottoming Layer	Diaphragm Layer	Velcro® Kit Included	Improved Pressure Management	Recommended for Long Surgeries	Anti-Shear Cover	2" (5 cm) Thickness	3" (7.6 cm) Thickness	3.25" (8.2 cm) Thickness	4" (10 cm) Thickness	4.25" (10.8 cm) Thickness	5" (12.7 cm) Thickness	5.25" (13.3 cm) Thickness
Astrus Elite	OR Table Surfaces	●	●	●	●	●	●	●	●		●		●		●	
	Armboard Surfaces	●	●	●	●		●	●	●		●	●	●	●	●	●
Standard & Deluxe	OR Table Surfaces		●			●										
	Armboard Surfaces		●							●	●		●			

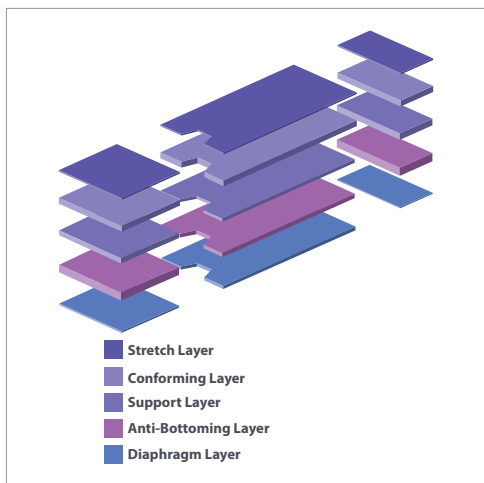

Astrus Elite™ Surfaces

Effective Pressure Management Our Astrus Elite Surfaces have a 4-layer foam composite construction that helps protect patients four ways. A top layer of conforming foam molds to your patients' anatomy. The pressure displacement foam middle layer transfers pressure off the bony prominences and the closed cell foam bottom layer prevents bottoming out. The anti-shear cover helps protect patient's skin. Offered with integral gel layer (gray bottom) or without (black bottom.) Available in 3" (7.6 cm) and 4" (10 cm). Velcro® kit included. Non-conductive.

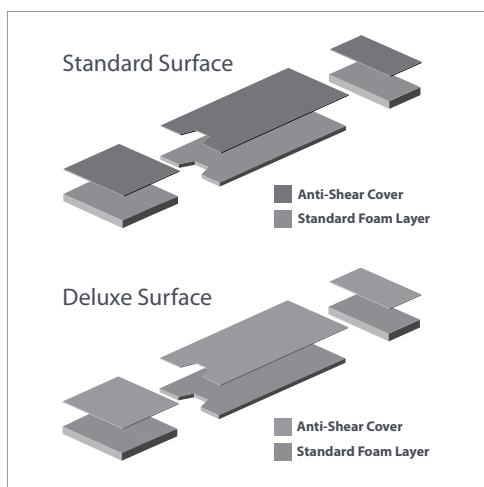

Standard & Deluxe Surfaces

Standard Surfaces: Our conductive Standard Surface is equivalent to the pads that are typically provided with new surgical tables. It combines supportive urethane foam with a 'Lectrolite®' cover.

Deluxe Surfaces: Our conductive Deluxe Surface features supportive foam and a stretchable cover for added patient comfort. Recommended for use during shorter procedures and with patients who are determined to be at lower risk for developing pressure injuries. Velcro® kit included.

Astrus Elite & Standard Surface: Pressure Mapping Results

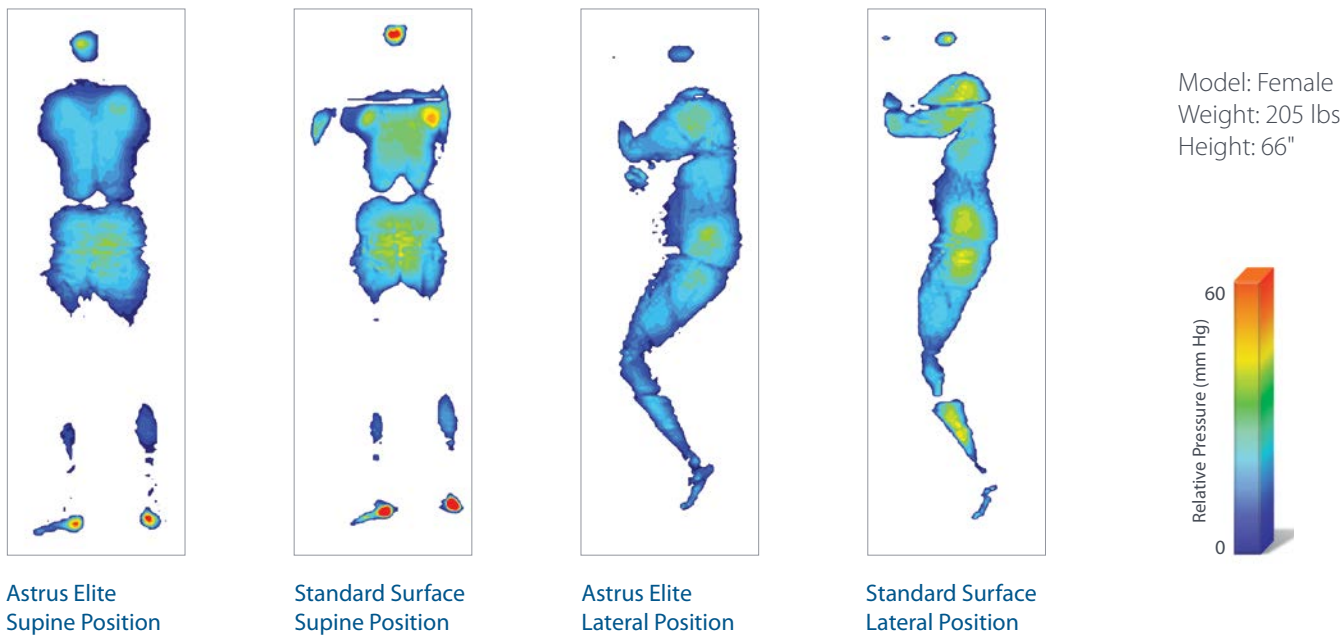

Astrus Elite™ OR Table Pad Sets



Standard & Deluxe OR Table Pad Sets



	Astrus Elite - Order Info		Standard - Order Info	Deluxe - Order Info
	3" Pad	4" Pad	2" Pad	2" Pad
OR Table Manufacturer / Model Name	Product No.	Product No.	Product No.	Product No.
Berchtold B810, B710	H-303-12-100	n/a	H-201-12-100	H-202-12-100
Berchtold Operon D850, D750 (long foot)	H-303-12-120	n/a	H-201-12-120	H-202-12-120
Berchtold Operon D850, D750 (short foot)	H-303-12-130	n/a	H-201-12-130	H-202-12-130
Getinge / Champagne 5100B, 5100E	H-303-04-130	H-403-04-130	H-201-04-130	n/a
Skytron 5001, 6001, 6500, 6600	H-303-05-130	H-403-05-130	H-201-05-130	H-202-05-130
Skytron 3100	H-303-05-100	H-403-05-100	n/a	H-202-05-100
Skytron 3500	H-303-05-120	H-403-05-120	H-201-05-120	H-202-05-120
Skytron 3600	H-303-05-190	H-403-05-190	H-201-05-190	H-202-05-190
Skytron 6700, 6701	H-303-05-200	H-403-05-200	H-201-05-200	H-202-05-200
Steris-Amsco 1080, 2080	H-303-03-100	n/a	H-201-03-100	H-202-03-100
Steris-Amsco 3080, 3085	H-303-03-110	H-403-03-110	H-201-03-110	H-202-03-110
Steris Cmax / Steris 4085	H-303-03-150	H-403-03-150	H-201-03-150	H-202-03-150
Steris SurgiGraphic 6000	H-303-03-170	n/a	H-201-03-170	H-202-03-170

Note: Pad products, including gel pads, FlexiForm™, Allen® Hug-U-Vac® and foam positioners, returned within thirty (30) days of the invoice date are subject to a 20% restocking fee.

OR Table Pad Sizing Chart

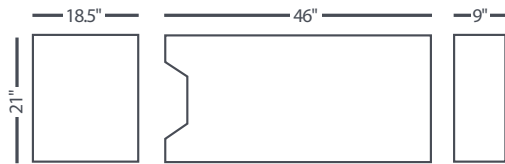

Berchtold B810, B710

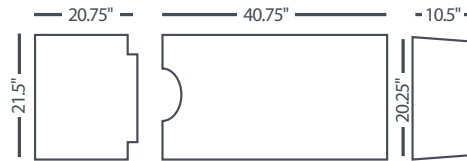

Maquet 1130

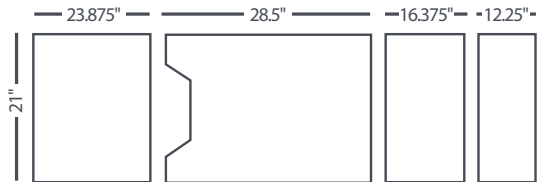

Berchtold D850, D750 (long foot)

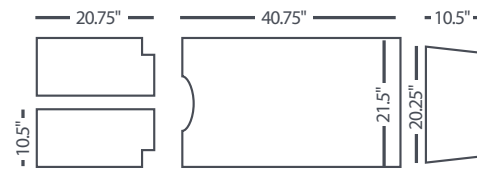

Maquet 1130 Split Leg

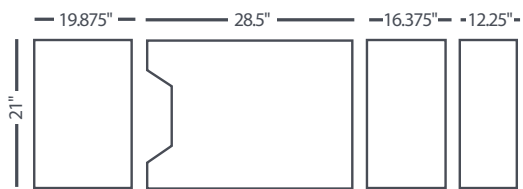

Berchtold D850, D750 (short foot)

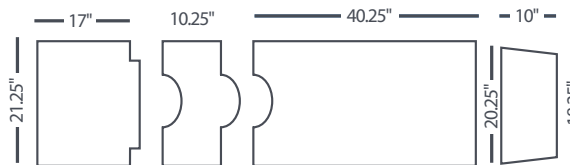

Maquet 1130 Orthopedic

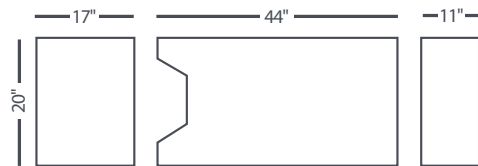

Getinge / Champagne 4900B

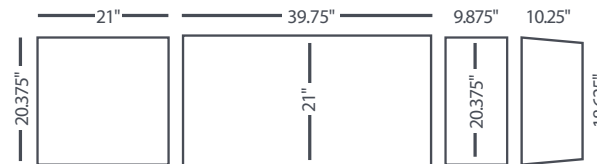

Maquet Alphastar 1132



Maquet Alphamaxx (long torso)



Midmark 7100

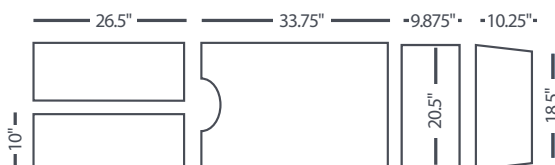

Maquet Alphamaxx (short torso)

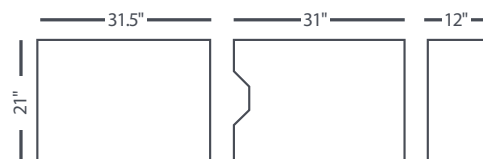

Midmark Chic CST

OR Table Pad Sizing Chart

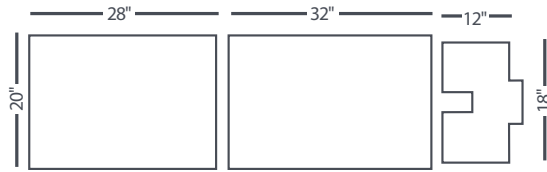

Midmark Montreal

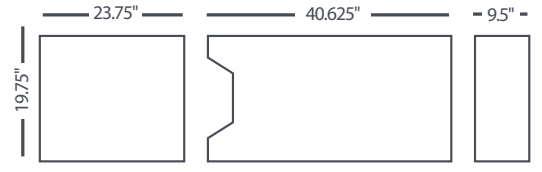

Skytron 5001 / 6001 / 6500 / 6600

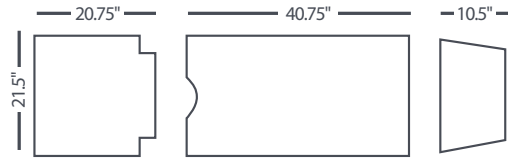

Siemens Universal

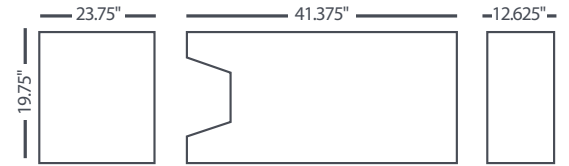

Skytron 6700

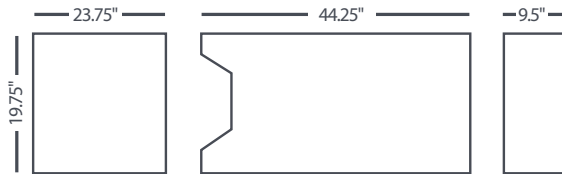

Skytron 3500

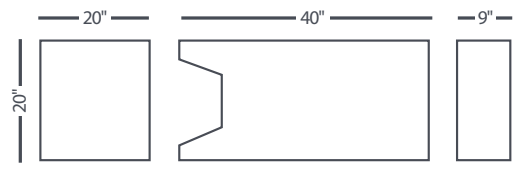

Steris/Amsco 1080 / 2080

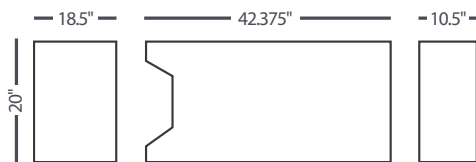

Steris/Amsco 3080 / 3085

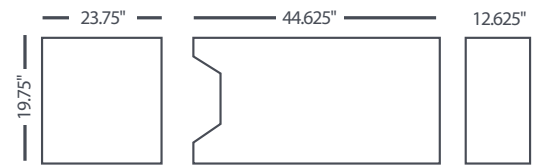

Skytron 3600

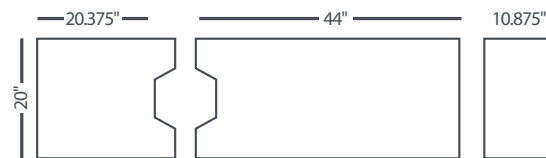

Steris Cmax / Steris 4085

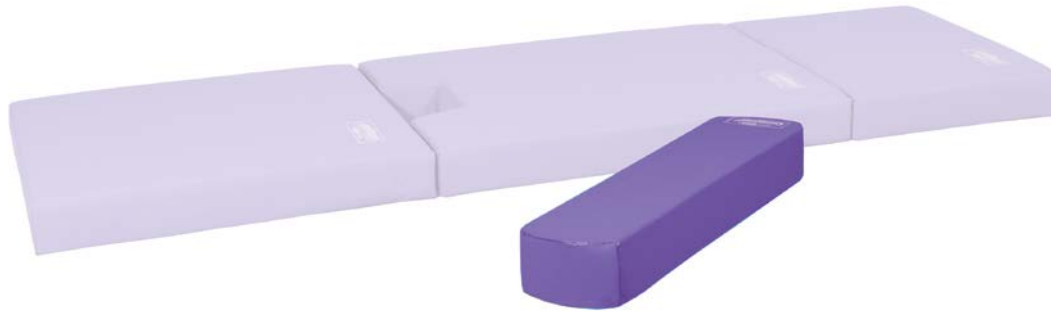

Choose Your Armboard Style

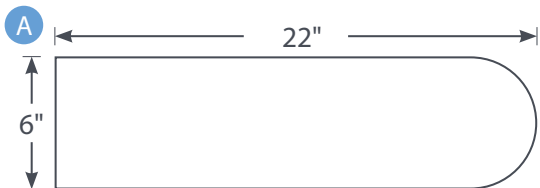

Fits armboard models:
• Allen® Japanese

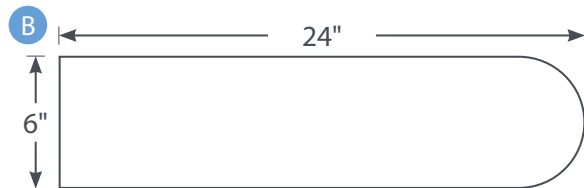

Fits most armboard models:
• Getinge® • MDT
• Maquet® • Shampaine®



Fits most armboard models:
• Allen • Schaerer Mayfield®
• Amsco® • Siemens®
• Berchtold® • Steris®



Fits armboard models:
• Skytron®

All armboard pads sold individually.



Astrus Elite™ Armboards Surfaces

Effective Pressure Management - Astrus Elite Surfaces have a 4-layer foam composite construction that helps protect patients four ways. Allen® armboard surfaces are available for armboards in both regular and contoured styles. Allen contoured armboard surface rounds up at the sides an extra .5" (1.3 cm) for increased stability.

All armboard pads sold individually.

Standard Surfaces



	Astrus Elite Standard - Order Info	
	3" Pad	4" Pad
	Product No.	Product No.
Allen, Steris-Amsco	H-303-03-950	H-403-03-950
Maquet	H-303-10-950	H-403-10-950
Getinge / Shampaine	H-303-04-950	H-403-04-950
Skytron	H-303-05-950	H-403-05-950

Contoured Surfaces



	Astrus Elite Contoured - Order Info	
	3" Pad	4" Pad
	Product No.	Product No.
Allen, Steris-Amsco	H-303-03-960	H-403-03-960
Getinge / Shampaine	H-303-04-960	H-403-04-960
Skytron	H-303-05-960	H-403-05-960



Standard & Deluxe Armboards Surfaces

Deluxe Surfaces: Recommended for use during shorter procedures and with patients who are determined to be at lower risk for developing pressure injuries. Velcro® kit included.

Standard Surfaces: Our conductive Standard Surface is equivalent to the pads that are typically provided with new surgical tables.

All armboard pads sold individually.

Standard Surfaces



	Standard - Order Info		Deluxe - Order Info	
	2" Pad	3" Pad	2" Pad	3" Pad
	Product No.	Product No.	Product No.	Product No.
Allen®, Steris-Amsco	H-201-03-950	H-301-03-950	H-202-03-950	H-302-03-950
Maquet	H-201-10-950	H-301-10-950	H-202-10-950	H-302-10-950
Getinge / Shampaine	H-201-04-950	n/a	H-202-04-950	H-302-04-950
Skytron	H-201-05-950	H-301-05-950	H-202-05-950	H-302-05-950

Allen® Gel Positioners

Features

- Constructed with an advanced silicone formula designed to help with pressure redistribution
- Flexible membrane cover
- Will not absorb body fluids or odors
- Radiolucent

Armboard & Toboggan Pads



Small Armboard Gel Pad
15.5" x 4.5" x .375"
(395 x 115 x 10 mm)
#A-10105 (sold individually)



Large Armboard Gel Pad
23.625" x 5" x .375"
(600 x 125 x 10 mm)
#A-10032 (sold individually)



Allen® Armboard Gel Pad
23.625" x 8" x .375"
(600 x 200 x 10 mm)
#A-10035 (sold individually)



Allen Premium Armboard Gel Pad - Short
13" x 5.5" x 1.2"
(330 x 140 x 30 mm)
#A-10036 (sold individually)



Allen Premium Armboard Gel Pad - Long
18.5" x 7" x 1.5"
(460 x 180 x 35 mm)
#A-10037 (sold individually)



Toboggan Gel Pad
15.5" x 10" x .375"
(395 x 245 x 10 mm)
#A-10029 (sold in pairs)

Head Positioners



Adult Head Gel Donut
8" Outer Diameter x 2"
(200 x 45 mm)
#A-10031 (sold individually)



Pediatric Head Gel Donut
3.5" Outer Diameter x .75"
(90 x 20 mm)
#A-10103 (sold individually)



Adult Gel Horseshoe
8" Outer Diameter x 3"
(200 x 75 mm)
#A-10104 (sold individually)

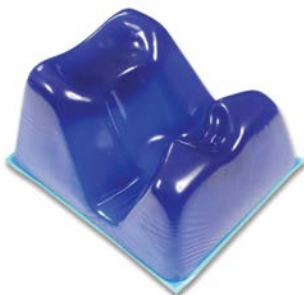

Allen® Prone Head Positioner - Large
11" x 9.5" x 5.5"
(280 x 240 x 140 mm)
#A-10038 (sold individually)



Allen Prone Head Positioner - Small
11" x 9" x 5.5"
(273 x 220 x 135 mm)
#A-10039 (sold individually)



Allen Silicone Head Positioner
8" x 10"
(203 x 254 mm)
#A-10045 (sold individually)

Knee Pads *Continued On Page 126*

Small Knee Crutch Gel Pad
12.625" x 8.625" x .375"
(320 x 220 x 10 mm)
#A-10070 (sold in pairs)



Medium Knee Crutch Gel Pad
15.5" x 10" x .375"
(395 x 245 x 10 mm)
#A-10029 (sold in pairs)



Allen® Prone Knee Pad - Long
20.5" x 6" x 1.5"
(510 x 150 x 35 mm)
#A-10040 (sold individually)

Knee Pads *Continued*



Allen Prone Knee Pad - Short
16" x 6" x 1.5"
(400 x 150 x 35 mm)
#A-10041 (sold individually)

Nerve & Heel Protectors



Large Ulnar Nerve Gel Elbow Pad With Velcro Straps
18" x 8.25" x .313"
(460 x 210 x 8 mm)
#A-10066 (sold individually)



Foot-Heel Gel Pad With Velcro Straps
.375" x 3.75" x 4.5"
(10 x 95 x 114 mm)
#A-10067 (sold in pairs)

Positioners



Heel Protector Gel Pad With Velcro Straps
9" x 7.875" x .875"
(230 x 200 x 20 mm)
#A-10068 (sold in pairs)



"Sandbag" Gel Positioner
Small: 12" x 4.75" x 2.375" (300 x 120 x 60 mm),
Large: 14" x 5" x 2.75" (360 x 125 x 70 mm)
#A-10073 (Small) (sold individually)
#A-10074 (Large) (sold individually)



Chest Roll Gel Positioner
12" x 4" x 3" (305 x 100 x 75 mm), 16" x 4" x 3"
(405 x 100 x 75 mm), 20" x 4" x 3" (510 x 100 x 75 mm)
#A-10076 (sold individually)
#A-10078 (sold individually)
#A-10080 (sold individually)



Chest Roll Gel Positioner With Foam Core
16" x 6" x 6" (405 x 150 x 150 mm),
20" x 6" x 6" (510 x 150 x 150 mm)
#A-10097 (sold individually)
#A-10098 (sold individually)



Allen® Prone Gel Positioner
44.5" x 21" x 5.5"
(1115 x 520 x 140 mm)
#A-10044 (sold individually)



Allen Lateral Gel Positioner
29" x 20" x 6.5"
(720 x 500 x 160 mm)
#A-10043 (sold individually)

Positioners *Continued*

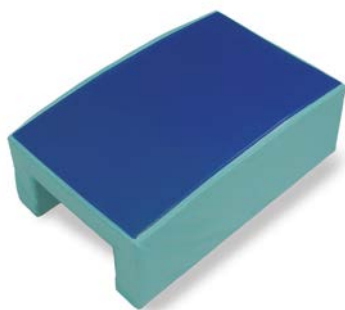

Allen Lateral Leg Positioner
26" x 16" x 9"
(650 x 400 x 230 mm)
#A-10042 (sold individually)

Overlay Table Pads



Head Section Gel Pad
9" x 20" x .375"
(225 x 500 x 10 mm)
#A-10034H (sold individually)



Torso Section Gel Pad With Cutout
39" x 20" x .375"
(990 x 500 x 10 mm)
#A-10034T (sold individually)



Foot Section Gel Pad
19" x 20" x .375"
(500 x 500 x 10 mm)
#A-10034F (sold individually)



3/4 Length: 45.25" x 20.5" x .375" (1150 x 520 x 10 mm),
Full Length: 71" x 20.5" x .375" (1800 x 520 x 10 mm)
#A-10060 (3/4 Length) Table Gel Pad
#A-10061 (Full Length) Table Gel Pad
(#A-10060 & #A-10061 are sold individually)

Lateral Positioning



- A** #A-10043 Allen® Lateral Gel Positioner
- B** #A-10066 Large Ulnar Nerve Gel Elbow Pad w/ Velcro® straps



- C** #A-10037 Allen Premium Armboard Gel Pad - Long
- D** #A-10029 Toboggan Gel Pad
- E** #A-10042 Allen Lateral Leg Positioner

Prone Positioning



- A** #A-10040 Allen Prone Knee Pad - Long
- B** #A-10097 Chest Roll Gel Positioner w/ Foam Core



- C** #A-10044 Allen Prone Gel Positioner
- D** #A-10038 Allen Prone Head Positioner - Large
- E** #A-10037 Allen Premium Armboard Gel Pad - Long

Product Index *Alphabetical*

#

4-Post System 35

A

Accessory Cart 104
Accessory Rail, Long 41
Accessory Rail, Short 40
Adjustable Accessory Rail & Clamp 41
Adjustable Footboard 110
Advance Accessory Cart 48
Advanced Arm Support 42
Advance Flat Top Pad 44
Advance Lateral Air Compressor 21
Advance Prone Support Set 16
Advance Table 13
Advance Table Complete Package 17
Advance Table H-Brackets 18
Advance Table L2P Platform 20
Advance Table Premium Package 17
Advance Table Standard Package 14
Advance Ultra Comfort Covers 46
Anesthesia Screen, Flexible 109
Anesthesia Screen With Wings 109
AP-Vantage, C-Flex 39
Armboard Pads
 Standard & Deluxe 123
Armboard Rail 40
Armboards
 Advanced Arm Support 42
 Articulating Arm Support 42
 Bariatric Armboard 113
 Easy Armboard Lift-to-Position 107
 Easy Armboard With Trigger 43 106
 LPS Arm Support 76 107
 Multi-Task Armboard 43 76 108
Arm & Hand Tables
 Basic Carpa Table 94
 Basic Hourglass Table 93
 Basic Rectangular Table 92
 Carbon Lights Hourglass Table 93
 Carbon Lights Minor Procedures Table 94
 Carbon Lights Rectangular Table 92
Arm Positioner 75
Arm Positioner Sterile Disposables 77
Arm Shield 108
Arm Support, LPS 76 107
Arm Traction Device 80
Arm Trap Disposables 81
Arthroscopic Stress Post 88
Arthroscopic Well-Leg Holder 87
Articulating Arm Support 42
Astrus Elite OR Table Surfaces 119
Astrus Elite Supine Top Pad 44
Autoclavable Clamp 102

B

Bariatric
 Armboard 113
 Hug-U-Vac Large Steep Trend Positioner 112
 Nissen Thigh Straps 112
 Table Width Extender 113
 Ultrafins Stirrups 112
Basic Carpa Table 94
Basic Hourglass Table 93
Basic Rectangular Table 92
Beach Chairs
 Beach Chair Cart 79 105
 Beach Chair Reusable Pad Set 78
 Counter-Traction Brace 78
 Counter-Traction Strap 78
 FlexiForm Head Rest Pad Disposables 77
 Intubation Plate and Pad 71
 Lift-Assist Beach Chair 69
 Lift-Assist Beach Chair Reusable Pad Set 79
 LPS Arm Support 76
Boot Pads
 Clamshell Boot Pads 67
 FootHugger Boot Pad 57
Boot, Traction 85
Bow Frame 33
Bow Frame Cart 48 105
Bow Frame Skin Care Covers Kit 45
Bow Frame Standard Covers Kit 45
Braces
 Arthroscopic Stress Post 88
 Counter-Traction Brace 78
 Counter-Traction Strap 78
 Lateral Braces 81
 Security Straps 110
Brachytherapy Drapes for Uro Catcher System 64

C

Carbon Lights Hourglass Table 93
Carbon Lights Minor Procedures Table 94
Carbon Lights Rectangular Table 92
Carts
 Accessory Cart 104
 Advance Accessory Cart 48
 Beach Chair Cart 79 105
 Bow Frame Cart 48 105
 Stirrup Cart 104
Cervical Traction Bar 15 18
Cervical Traction Device 18
C-Flex Accessories 37
C-Flex AP-Vantage System 39
C-Flex Head Positioning System 37
Clamps
 Autoclavable 102
 Clamp for Adjustable Accessory Rail 41
 Easy Lock Blade Clamp 101

- Easy Lock Socket 101
- Rail Clamp 103
- Simple Clamp 103
- Tri-Clamp Device 102
- Universal Accessory Clamp 102
- Clamshell Boot Pads 67
- Comfort Cover Disposables 46
- Comfort Mask Disposables 47
- Comfort Mat 108
- Contour Breast Positioner 31
- Counter-Traction Brace 78
- Counter-Traction Strap 78
- C-Prone 29
- C-Prone Head Positioner 47

D

- Deluxe Arthroscopic Leg Holder 86
- Disposables
 - Arm Positioner Sterile Disposables 77
 - Arm Trap Disposables 81
 - Bow Frame Skin Care Covers Kit 45
 - Bow Frame Standard Covers Kit 45
 - Comfort Cover Disposables 46
 - Comfort Mask Disposables 47
 - Easy Catcher Disposable System 63
 - Finger Trap Disposables, Sterile Mesh 96
 - FlexiForm Head Rest Pad Disposables 77
 - Leg Holder Disposable Pads 86
 - Universal Head Restraint Disposables 77
- Drapes
 - Brachytherapy Drapes for Uro Catcher 64
 - Safety Drape 53
 - Uro Catcher Drapes 64

E

- Easy Armboard Lift-to-Position 107
- Easy Armboard With Trigger 43 106
- Easy Catcher Disposable System 63
- Easy Irrigation Tower 65
- Easy Lock Blade Clamp 101
- Easy Lock Socket 101
- Easy Rack 106
- Equalizer, The 95
- Extremity Positioner 111

F

- Finger Trap Disposables, Sterile Mesh 96
- Finger Trap Sizing Kit 96
- Finger Traps Sizing Kit 96
- Finger Trap Sterile Starter Kit 96
- Flex Frame Spine System *See Spine*
- Flexible Anesthesia Screen 109
- FlexiForm Head Rest Pad Disposables 77
- Foam Head Block Stand 33 47

- Foam Positioners
 - Extremity Positioner 111
 - Foam Head Block 46
 - Frogger Pad 111
 - Well-Leg Holder 87 111
- Foam Well-Leg Holder 87 111
- Footboard, Adjustable 110
- FootHugger Boot Pad 57
- Frogger Pad 111

G

- Gel Pads & Positioners
 - Armboard & Toboggan Pads 124
 - Head Positioners 125
 - Knee Pads 125 126
 - Nerve & Heel Protectors 126
 - Overlay Table Pads 127
 - Positioners 126 127

H

- Hand Positioner, Schlein 96
- H-Brackets, Advance Table 18
- Head Block, Foam 46
- Head Positioner, C-Prone 47
- Head Positioner, Universal 73
- Hug-U-Vac Lateral Positioners 83
- Hug-U-Vac Steep Trend Positioners 61 112

I

- Irrigation Tower, Easy 65

J

- Junior PAL Pediatric Stirrups 59

K

- Knee Crutch, Simplicity 66
- Knee Stabilizer, Total 88

L

- Large Patient *See Bariatric*
- Lateral Braces 81
- Lateral Positioners, Hug-U-Vac 83
- Leg Holder, Deluxe Arthroscopic 86
- Leg Holder Disposable Pads 86
- Leg Holder, Foam Well-Leg 87 111
- Lift-Assist Beach Chair 69

Little PAL Pediatric Stirrups 59
Long Accessory Rail 41
LPS Arm Support 76 107

M

Mat, Comfort 108
Multi-Task Armboard 43 76 108

N

Needle Trier Device 109
Nissen Thigh Straps 67
Nissen Thigh Straps, Bariatric 112

O

Offset Accessory Rail - Left 21
Offset Accessory Rail - Right 21
OR Table Surfaces
Astrus Elite 119
Deluxe 119
Standard 119
Stretcher Pads *See Stretcher Surfaces*

P

Pads
Advance Flat Top Pad 44
Astrus Elite 119
Astrus Elite Supine Top Pad 44
Clamshell Boot Pads 67
Deluxe OR Table 119
FootHugger Boot Pad 57
Frogger Pad 111
Gel Pads *See Gel Pads and Positioners*
Junior PAL Clamshell Pad 59
Little PAL Clamshell Pad 59
Standard OR Table 119
Stirrup Pads *See Boot Pads*
Table Pads *See OR Table Surfaces*
Ultrafins Clamshell Pad 53
PAL, Junior Stirrups 59
PAL, Little Stirrups 59
PAL Pro Stirrups 57
Patient Transfer Board 99
Pediatric Stirrups 59
Prepper Device, The 89
Prone Arm Support 42

R

Rack, Easy 106
Rail Clamp 103

S

Safety Drape 53
Schlein Hand Positioner 96
Security Straps 110
Short Accessory Rail 40
Shoulder Positioners *See Beach Chairs*
Shoulder Supports 66
Shoulder Suspension System, Weightless 80
Simple Clamp 103
Simplicity Knee Crutch 66
Spine
4-Post System 35
Adjustable Accessory Rail & Clamp 41
Advanced Arm Support 42
Advance Flat Top Pad 44
Advance Prone Support Set 16
Advance Table 13
Advance Table Complete Package 17
Advance Table H-Brackets 18
Advance Table L2P Platform 20
Advance Table Premium Package 17
Advance Table Standard Package 14
Advance Ultra Comfort Covers 46
Articulating Arm Support 42
Astrus Elite Supine Top Pads 44
Bow Frame 33
Bow Frame Cart 48 105
Bow Frame Skin Care Covers Kit 45
Bow Frame Standard Covers Kit 45
Cervical Traction Bar 18
Cervical Traction Device 18
C-Flex AP-Vantage System 39
C-Flex Head Positioning System 37
Comfort Cover Disposables 46
Comfort Mask Disposables 47
C-Prone 29
C-Prone Head Positioner 47
Flex Frame OR Table Clamp Set 28
Flex Frame Spine System 27
Foam Head Block 46
Prone Arm Support 42
Spine System 27
Spine System Lateral Package 29
Supine Top Set 44
Wingset Body Positioners 31
Spine System 27
Steep Trend Positioners, Hug-U-Vac 61
Steep Trend Secondary Supports 61
Sterile Arm Trap Disposables 81
Stirrup Cart 104
Stirrups
Junior PAL Pediatric Stirrup 59
Little PAL Pediatric Stirrup 59
PAL Pro Stirrups 57
The Twister Device 67
Ultrafins Stirrups 53
Yellofins Elite Stirrups 55
Yellofins Stirrups 55
Yellofins without Lift-Assist 55
Storage *See Carts*
Straps *See Security Straps*
Stress Post, Arthroscopic 88

T

Table Pads *See* OR Table Surfaces
Table Width Extender 66
Table Width Extender, Bariatric 113
The Equalizer 95
The Prepper Device 89
Thigh Straps, Nissen 67
Total Knee Stabilizer 88
Traction Boot 85
Transfer Board, Patient 99
Tri-Clamp Device 102
Twister Device, The 67

U

Ultrafins Stirrups 53
Universal Accessory Clamp 102
Universal Head Positioner 73
Universal Head Restraint Disposables 77
Uro Catcher
 Brachytherapy Drapes for Uro Catcher 64
 Uro Catcher Drapes 64
 Uro Catcher System 64

W

Weightless Shoulder Suspension System 80
Well-Leg Holder, Arthroscopic 87
Well-Leg Holder, Foam 87 111
Wingset Body Positioners 31
Wingset, Chest 31
Wingset, Chest, Radiolucent Screws 31
Wingset, Contour Breast Positioner 31
Wingset, Hip, Cut-Out 31
Wingset, Hip, Radiolucent Screws 31
Wingset, Pediatric 31
Wingset, Standard 31
Wrist Arthroscopy System 95

Y

Yellofins Elite Stirrups 55
Yellofins Reusable Pad 55
Yellofins Stirrups 55

Product Index *By Part Number*

#A-10015	Deluxe Arthroscopic Leg Holder	86
#A-10028-C	FootHugger Bot Pad	57
#A-10029	Toboggan Gel Pad, Medium Knee Crutch Gel Pad	124, 125
#A-10031	Adult Head Gel Donut	125
#A-10032	Large Armboard Gel Pad	124
#A-10034F	Foot Section Gel Pad	127
#A-10034H	Head Section Gel Pad	127
#A-10034T	Torso Section Gel Pad With Cutout	127
#A-10035	Allen Armboard Gel Pad	124
#A-10036	Allen Premium Armboard Gel Pad - Short	124
#A-10037	Allen Premium Armboard Gel Pad - Long	124
#A-10038	Allen Prone Head Positioner - Large	125
#A-10039	Allen Prone Head Positioner - Small	125
#A-10040	Allen Prone Knee Pad - Long	125
#A-10041	Allen Prone Knee Pad - Short	125
#A-10042	Allen Lateral Leg Positioner	127
#A-10043	Allen Lateral Gel Positioner	126
#A-10044	Allen Prone Gel Positioner	126
#A-10045	Allen Silicone Head Positioner	125
#A-10052	PAL Pro without Integral Clamp	57
#A-10055	Pediatric Stirrup Package	59
#A-10056	Junior PAL Stirrups	59
#A-10057	Little PAL Stirrups	59
#A-10058	Junior PAL Clamshell Pad	59
#A-10059	Little PAL Clamshell Pad	59
#A-10060	(3/4 Length) Table Gel Pad	127
#A-10061	(Full Length) Table Gel Pad	127
#A-10066	Large Ulnar Nerve Gel Elbow Pad With Velcro Straps	126
#A-10067	Foot-Heel Gel Pad With Velcro Straps	126
#A-10068	Heel Protector Gel Pad With Velcro Straps	126
#A-10070	Small Knee Crutch Gel Pad	125
#A-10073	Small "Sandbag" Gel Positioner	126
#A-10074	Large "Sandbag" Gel Positioner	126
#A-10076	Chest Roll Gel Positioner 12" x 4" x 3" (305 x 100 x 75 mm)	126
#A-10078	Chest Roll Gel Positioner 16" x 4" x 3" (405 x 100 x 75 mm)	126
#A-10080	Chest Roll Gel Positioner 20" x 4" x 3" (510 x 100 x 75 mm)	126
#A-10097	Chest Roll Gel Positioner With Foam Core 16" x 6" x 6" (405 x 150 x 150 mm)	126
#A-10098	Chest Roll Gel Positioner With Foam Core 20" x 6" x 6" (510 x 150 x 150 mm)	126
#A-10103	Pediatric Head Gel Donut	125
#A-10104	Adult Gel Horseshoe	125
#A-10105	Small Armboard Gel Pad	124
#A-10319	Velcro Straps for Stirrups	57
#A-20500	Arm Traction Device	80
#A-20750	Schlein Hand Positioner	96
#A-21200	Sterile Arm Trap Disposables	81
#A-22000	Safety Drape	53
#A-30010	Accessory Cart (US)	104
#A-30011 (US)	Accessory Hook (US)	79
#A-30011E (EU)	Accessory Hook EU	79
#A-30011J (Jpn)	Accessory Hook (Japan)	79
#A-30015	Stirrup Cart	104
#A-30300-Pad	Carbon Lights Rectangular Table 2" (5 cm) Pad	92
#A-30300-Pad-1	Carbon Lights Rectangular Table 1" (2.5 cm) Pad	92
#A-30410-C	Carbon Lights Minor Procedures Table	94
#A-30410-Pad	Carbon Lights Minor Procedures Table 2" (5 cm) Pad	94
#A-30410-Pad1	Carbon Lights Minor Procedures Table 1" (2.5 cm) Pad	94
#A-30450-C	Carbon Lights Rectangular Table	92

#A-30450-LEG	Optional Leg 92
#A-30502-1-B	Pad Set for A-30650-C 1" (2.5 cm) 93
#A-30502-B	Pad Set for A-30650-C 2" (5 cm) 93
#A-30522-1	Finger Traps - Cases - Double, Large 96
#A-30522-2	Finger Traps - Cases - Single, Large 96
#A-30522-3	Finger Traps - Cases - Double, Medium 96
#A-30522-4	Finger Traps - Cases - Single, Medium 96
#A-30522-5	Finger Traps - Cases - Single, Small 96
#A-30522-6	Finger Traps - Cases - Double, Small 96
#A-30522-7	Finger Traps - Cases - Double, Extra Large 96
#A-30522-8	Finger Traps - Cases - Single, Extra Large 96
#A-30530-1	Elbow Rest Pads 93
#A-30650-C	Carbon Lights Hourglass Table 93
#A-30650-Clamp	Replacement Clamp 93
#A-30650ER	Elbow Rest 93
#A-40015	Universal Accessory Clamp (US Only) 102
#A-40016	Tri-Clamp (US) 102
#A-40018	Simple Clamp (US/EU) 103
#A-40018-UK	Simple Clamp (UK) 103
#A-40022	Easy Lock Socket (US) 101
#A-40023	Easy Lock Socket (EU) 101
#A-40024	Easy Lock Socket (UK) 101
#A-40025	Easy Lock Socket (Denyer) 101
#A-40030	Easy Lock Socket (Japan) 101
#A-40040	Easy Lock Blade Clamp (US) 101
#A-40041	Easy Lock Blade Clamp (EU) 101
#A-40042	Easy Lock Blade Clamp (UK) 101
#A-40043	Easy Lock Blade Clamp (Japan) 101
#A-50008	Brachytherapy Drapes for Uro Catcher System, Sterile 64
#A-60001	Allen Hug-U-Vac Steep Trend Positioner 61
#A-60002	Allen Hug-U-Vac Lateral Positioner, Large 83
#A-60003	Allen Hug-U-Vac Lateral Positioner, Standard 83
#A-60005	Allen Hug-U-Vac Large Steep Trend Positioner 61, 112
#A-60010	Steep Trend Positioners Package 61
#A-60101	Allen Hug-U-Vac Steep Trend Disposable Covers, Standard 61
#A-60102	Allen Hug-U-Vac Lateral Disposable Covers, Large 83
#A-60103	Allen Hug-U-Vac Lateral Disposable Covers, Standard 83
#A-60105	Allen Hug-U-Vac Steep Trend Disposable Covers, Large 61
#A-63500	Shoulder Supports 66
#A-63500PAD	Shoulder Supports Replacement Pads 66
#A-63600	Allen Steep Trend Secondary Supports 61
#A-70000	Allen Spine System (Standard System with C-Prone) 29
#A-70002	Allen Spine System (Premium System with C-Flex) 29
#A-70100	Flex Frame 28
#A-70110	C-Flex AP-Vantage (with C-Flex Head Positioning System) 39
#A-70111	C-Flex AP-Vantage (without C-Flex Head Positioning System) 39
#A-70115	C-Flex AP-Vantage OR Table Adaptor 39
#A-70116	C-Flex AP-Vantage Leg 39
#A-70117	C-Flex Traction Bar 39
#A-70118	C-Flex 45° Starburst Adaptor 39
#A-70200	Standard Wingset System 31
#A-70201	Cut-Out Hip Wingset 31
#A-70202	Pediatric Wingset System Hip & Chest 31
#A-70203	Standard Chest Wingset 31
#A-70204	Chest Wingset With Radiolucent Screws 31
#A-70205	Hip Wingset With Radiolucent Screws 31
#A-70207	Allen 4-Post System Frame 35
#A-70208	Long Attachment Straps 35
#A-70209	Replacement Short Attachment Straps 35
#A-70220	Standard Wingset Replacement Pads 31
#A-70221	Pediatric Wingset Replacement Pads 31
#A-70230	Spine System Lateral Package 29

#A-70257 Lateral Hip Pad 29
 #A-70260 Comfort Cover Disposables 46
 #A-70270 Contour Breast Positioner 31
 #A-70300 C-Prone Head Positioner 47
 #A-70310 Comfort Mask Disposables 47
 #A-70400 Supine Top Set 44
 #A-70404 Supine Accessory Top 12" (30.5 cm) 16
 #A-70434 Astrus Elite 2" (5 cm) Supine Top Pads 44
 #A-70435 Astrus Elite 3" (7.6 cm) Supine Top Pads 44
 #A-70436 Allen Advance Flat Top Pad 44
 #A-70500 Armboard Rail 40
 #A-70501 Short Accessory Rail 40
 #A-70502 Long Accessory Rail 41
 #A-70510 Flex Frame OR Table Clamp Set 28
 #A-70610 Prone Arm Support 42
 #A-70615-US Advanced Arm Support 42
 #A-70700 C-Flex Head Positioning System 37
 #A-70701 C-Flex Head Positioning System Base Unit 37
 #A-70702 C-Flex Clean Cape Disposables 39
 #A-70710 Starburst Adaptor for Standard Mayfield or DORO 37
 #A-70715 Prone Head Mask Module 37
 #A-70720 Flat Plate Head Module 37
 #A-70725 Reverse Starburst Adaptor for Standard Mayfield or DORO 37
 #A-70730 Starburst Adaptor for Radiolucent Mayfield 37
 #A-70735 Reverse Starburst Adaptor for Radiolucent Mayfield 37
 #A-70740 Starburst Adaptor for Radiolucent DORO 37
 #A-70745 Reverse Starburst Adaptor for Radiolucent DORO 37
 #A-70750 45° Standard Starburst for Radiolucent Mayfield 37
 #A-70755 45° Standard Starburst for Radiolucent DORO 37
 #A-70800 Bow Frame 33
 #A-70801 Allen Bow Frame 33
 #A-70805 Bow Frame Standard Covers Kit 45
 #A-70810 Bow Frame Skin Care Covers Kit 45
 #A-70810C Bow Frame Skin Care Covers 45
 #A-70815 Bow Frame Cart 48, 105
 #A-70820 Bow Frame Old Style Replacement Pad Set 33
 #A-70822 Bow Frame New Replacement Pad Set 33
 #A-70821 Crank Arm 33
 #A-70825 Foam Head Block Stand 47
 #A-70862 Allen Foam Head Block 46
 #A-70863 Foam Arm Supports 16
 #A-71001 Allen Advance Table Standard Package 14
 #A-71002 Allen Advance Table Premium Package 17
 #A-71003 Allen Advance Table Complete Package 17
 #A-71100 Advance Table 15
 #A-71200 Allen 4-Post System, Standard Height Package 35
 #A-71201 Allen 4-Post System, Low Height Package 35
 #A-71261 Small Ultra Comfort Covers 46
 #A-71262 Medium Ultra Comfort Covers 46
 #A-71263 Large Ultra Comfort Covers 46
 #A-71300 Allen Advance Prone Support Set 16
 #A-71301 Chest Support With Pad 16
 #A-71303 Small Hip Support With Pad 16
 #A-71305 Medium Hip Support With Pad 16
 #A-71307 Large Hip Support With Pad 16
 #A-71309 Left Thigh Support With Pad 16
 #A-71311 Right Thigh Support With Pad 16
 #A-71312 Sling Support 16
 #A-71313 Allen Advance Pillow – Queen 15
 #A-71314 Allen Advance Pillow – Standard 15
 #A-71316 Head Plate 16
 #A-71319 Articulating Arm Support 42

#A-71320 Articulating Arm Support Clamp 10" (25.4 cm) 42
 #A-71321 Articulating Arm Support Replacement Pad 42
 #A-71400 Advance Rail Top 15
 #A-71401 Advance Pins 15
 #A-71402 Advance Table Standard H-Bracket 18
 #A-71413 Advance Table Pendant 15
 #A-71404 Cervical Traction Bar 15
 #A-71405 Power Cord 15
 #A-71410 Advance Flat Top 15
 #A-71411 Advance Safety Straps 15
 #A-71414 Pinless Brackets & Cervical Traction Device Pinless Package 19
 #A-71415 Pinless Brackets & Cervical Traction Device Pinless Package 19
 #A-71416 Advance Table Pinless H-Bracket 19
 #A-71417 Cervical Traction Device 18
 #A-71501 Adjustable Accessory Rail 41
 #A-71502 Clamp for Adjustable Accessory Rail 41
 #A-71600 Advance Accessory Cart 48
 #A-71700 Advance Table L2P Platform 20
 #A-71701 Advance Lateral Top 21
 #A-71702-L Advance Lateral Bracket 21
 #A-71702-P Advance Prone Bracket 21
 #A-71703 Advance Lateral Top Pad 21
 #A-71704 Advance Lateral Air Bladder 21
 #A-71705-US Advance Lateral Air Compressor 21
 #A-71706 Advance Lateral Drawsheet 21
 #A-71708-1 Offset Accessory Rail - Left 21
 #A-71708-2 Offset Accessory Rail - Right 21
 #A-71709 Air Compressor Tube Set 21
 #A-75000 Needle Trier Device 109
 #A-80100 Table Width Extender 8" x 15" (20 cm x 38 cm) 113
 #A-80150 Table Width Extender 8" x 11" (20 cm x 28 cm) 113
 #A-80200 Bariatric Armboard 113
 #A-80400 Bariatric Nissen Thigh Straps (US) 112
 #A-80400E Bariatric Nissen Thigh Straps (EU) 112
 #A-80400UK Bariatric Nissen Thigh Straps (UK) 112
 #A-83000 Long, Wide Patient Transfer Board 99
 #A-83001 Short, Narrow Patient Transfer Board 99
 #A-83002 Disposable Covers 99
 #A-83005 Long, Narrow Patient Transfer Board 99
 #A-83015 Narrow Board Replacement Cap 99
 #A-83016 Wide Board Replacement Cap 99
 #A-83017 Narrow Board Replacement Strap 99
 #A-83018 Wide Board Replacement Strap 99
 #A-90001 Counter-Traction Brace 78
 #A-90002 LPS Arm Support 76, 107
 #A-90015 Counter-Traction Strap 78
 #A-90019 FlexiForm Head Rest Pad Disposables 77
 #A-90020 Beach Chair Reusable Pad Set 78
 #A-90023 Universal Head Restraint Disposables 77
 #A-90025 Replacement Straps 73
 #A-90026 Universal Head Positioner 73
 #A-90040 Lift-Assist Beach Chair Reusable Pad Set 79
 #A-90100 Beach Chair Cart (US) 79, 105
 #A-90100E Beach Chair Cart (EU) 79, 105
 #A-90100J Beach Chair Cart (Japan) 79, 105
 #A-91500 Allen Lift-Assist Beach Chair 69
 #A-91501 Allen Lift-Assist Beach Chair 71
 #A-91502 Intubation Plate 71
 #A-91503 Lift-Assist Beach Chair Clamp 71
 #A-92000 Allen Arm Positioner 75
 #A-92001 Allen Arm Positioner Sterile Disposable 77
 #A-92002 Autoclavable Clamp 102

#A-92003	Replacement Arm Support	75
#A-93000	Traction Boot, Maquet/Schaerer Systems	85
#A-93001	Traction Boot Disposable	85
#A-93002	Traction Boot, Clamp for Maquet/Schaerer Systems	85
#A-93005	Traction Boot, Mizuho OSI Ovation and Modular Table Systems	85
#A-93005	Traction Boot, Steris OrthoVision System	85
#A-93006	Traction Boot, Clamp for Steris	85
#A-93007	Traction Boot, Clamp for Mizuho OSI	85
#A-AMA74	LPS Arm Support Replacement Pad	42
#C-008001	Replacement C-Clip Hug-U-Vac	61, 83
#H-009-00-100	Frogger Pad	111
#H-009-00-110	Extremity Positioner	111
#H-009-00-120	Foam Well-Leg Holder	87, 111
#H-201-(...)	Standard Armboard Surfaces 2"	123
#H-201-(...)	Standard OR Table Pads 2"	119
#H-202-(...)	Deluxe Armboard Surfaces 2"	123
#H-202-(...)	Deluxe OR Table Pads 2"	119
#H-301-(...)	Standard Armboard Surfaces 3"	123
#H-302-(...)	Deluxe Armboard Surfaces 3"	123
#H-303-(...)	Astrus Elite Armboard Surfaces 3"	123
#H-303-(...)	Astrus Elite OR Table Pads 3"	119
#H-403-(...)	Astrus Elite Armboard Surfaces 4"	123
#H-403-(...)	Astrus Elite OR Table Pads 4"	119
#O-ABMT	Multi-Task Armboard	43, 76, 108
#O-ABSL	Easy Armboard Lift-to-Position (US)	107
#O-ABSLT	Easy Armboard With Trigger (US)	43, 106
#O-AFB	Adjustable Footboard	110
#O-AHMPT	Basic Carpa Table	94
#O-AHMPTP	Basic Carpa Table 1.5" (3.8 cm) Pad	94
#O-AHTH	Basic Hourglass Table	93
#O-AHTHP1.5	Basic Hourglass Table 1.5" (3.8 cm) Pad	93
#O-AHTP	Basic Rectangular Table 1.5" (3.8 cm) Pad	92
#O-AHTR	Basic Rectangular Table	92
#O-AMA122X2.OR	Adjustable Footboard Pad	110
#O-AMA12X1.0S	Standard Armboard 1" (2.5 cm) Pad	43
#O-AMA34X1.0S	Table Width Extender 1" (2.5 cm) Pad	66
#O-AMA34X2.0S	Table Width Extender 2" (5 cm) Pad	66
#O-AMA34X3.0S	Table Width Extender 3" (7.6 cm) Pad	66
#O-AMA34X4.0S	Table Width Extender 4" (10 cm) Pad	66
#O-AMA53X0.6S	Arm Shield Pad	108
#O-AMA62S0.6S	Clamshell Boot Pads	67
#O-AMA68S0.6S	Yellofins Reusable Pad	55
#O-AMA96X2.0S	Clamshell Armboard 2" (5 cm) Pad	43
#O-AMA96X3.0S	Clamshell Armboard 3" (7.6 cm) Pad	43
#O-AMA97X1.0S	Clamshell Armboard 1" (2.5 cm) Pad	42
#O-AS	Arm Shield	108
#O-ASLW	Anesthesia Screen With Wings	109
#O-ASP	Arthroscopic Stress Post	88
#O-AWLH	Arthroscopic Well-Leg Holder	87
#O-CCPS	Replacement Straps	67
#O-CM	Comfort Mat	108
#O-EC51	Easy Catcher Disposable System, Sterile	63
#O-EC52	Easy Catcher Disposable System, Non-Sterile	63
#O-FAS	Flexible Anesthesia Screen	109
#O-HC	Heel Cups	67
#O-KCP	Simplicity Knee Crutch	66
#O-KCPP	Replacement Pads	66
#O-LHPCCA	The Twister Device	67
#O-LPA	Easy Irrigation Tower	65
#O-LPS	The Prepper Device	89
#O-LPSP	Replacement Disposable Pad	89
#O-MR2	Easy Rack (US)	106

#O-NTS	Nissen Thigh Straps (US) 67
#O-PRSH	Patient Security Strap Hooks 110
#O-PRSLH	Medium Security Strap (without hooks) 110
#O-RC2	Rail Clamp (US) 103
#O-RC29X32MM	Rail Clamp (Japan) 103
#O-RC2XD	Rail Clamp (Denyer) 103
#O-RC2XUK	Rail Clamp (EU/UK) 103
#O-RSX2	Large Security Strap (without hooks) 110
#O-S1007A0.6S	Arthroscopic Well-Leg Holder Boot Pad 87
#O-TKS	Total Knee Stabilizer with Pad 88
#O-TKSP	Total Knee Stabilizer Replacement Disposable Pad 88
#O-TSPP	The Twister Device Support Pole Pads 67
#O-TWE	Table Width Extender 4" (10 cm) US Rail 66
#O-TWEE	Table Width Extender 4" (10 cm) EU Rail 66
#O-TWEUK	Table Width Extender 4" (10 cm) UK Rail 66
#O-UC31	Uro Catcher Drapes, Sterile 64
#O-UC32	Uro Catcher Drapes, Non-Sterile 64
#O-UC4	Uro Catcher System (US) 64
#O-UFAS	Ultrafins Stirrups 53, 112
#O-UPBL3S	Lateral Braces 81
#O-UPBLC	Single Circular Support 81
#O-UPBLR	Single Rectangular Support 81
#O-YFASI	Yellofins Sirrups with Lift-Assist 55
#O-YFES	Yellofins Elite Sirrups with Lift-Assist 55
#O-YFSI	Yellofins Sirrups without Lift-Assist 55
#R-30522-888	Finger Trap Disposables Single Starter Kit 96
#R-30522-9	Finger Traps - Cases - Single, Pediatric Trap 96
#R-30522-999	Finger Trap Disposables Double Starter Kit 96
#R-50522-1	Sizing Kit 96
#R-644-36	Weightless Shoulder Suspension System 80
#R-734-05	The Equalizer 95
#R-734-10	Wrist Arthroscopy System 95
#R-S4133-V	Leg Holder Disposable Pads 86

Decimal to Fraction Equivalents	
Decimal	Fraction
0.063	1/16
0.125	1/8
0.188	3/16
0.250	1/4
0.313	5/16
0.375	3/8
0.438	7/16
0.500	1/2
0.563	9/16
0.625	5/8
0.688	11/16
0.750	3/4
0.875	7/8

Warranty Information

Allen products shall be free from defects in material and workmanship for a period two (2) years. There are exceptions to this as defined by the product groups or types as detailed below. Exceptions to the two (2) year warranty carry a one (1) Year Warranty as follows:

- Allen® Advance Table
- Advance Table L2P™ Platform
- Allen Hug-U-Vac®
- Pad products inclusive of the following:
 - Gel Pads, Vacu-Gel®, Vacu-Form®
- Foam Positioners

Warranty does not cover misuse, abuse, neglect, or lack of routine maintenance. In order for an item to be eligible for warranty, the serial or lot number must be on the product. Contact Customer Service or your Sales Representative for additional warranty information.

Return Policy - US Only

The guidelines below must be followed in order to initiate a return for credit:

- A Return Material Authorization (RMA) # must be obtained within thirty (30) days of invoice date by calling our Customer Service Department (800) 433-5774.
- An RMA number is valid for fourteen (14) calendar days. The RMA Label must be affixed to the outside of all shipping cartons. Product received without the RMA label or beyond this (14) day period will be refused.
- Product must be in new, unmarked, saleable condition. We will issue full credit following inspection of product. Product not in new condition is subject to a 20% restocking fee or may be returned with no credit.
- Pad products, including gel pads, Vacu-Gel, Vacu-Form, FlexiForm, Allen Hug-U-Vac and foam positioners, returned within thirty (30) days of the invoice date are subject to a 20% restocking fee.
- Shipment damages for product shipped using our carrier, should be reported to Customer Service Department within fourteen (14) days of invoice date.
- Disposable and Custom product is not returnable.

Copyright and Trademark Information

Copyright 2018, Allen Medical Systems, Inc. Allen®, Bow®, C-Flex®, Easy Catcher®, Easy Lock®, Hug-U-Vac®, Lift-Assist®, PAL®, PAL Pro®, Tri-Clamp®, Ultrafins®, Uro Catcher®, Vacu-Form®, Vacu-Gel® and Yellofins® are registered trademarks of Allen Medical Systems.

Active Heel™, Astrus Elite™, Banana Boot™, Carbon Lights™, Clear View™, Contour™, FootHugger™, FlexiForm™, Frogger™, Lift-Assist™, Needle Trier™, Simplicity™, The Prepper™, The Twister™ and Universal™ are trademarks of Allen Medical Systems.

Alphamaxx® is a registered trademark of Maquet GmbH. Alphastar® is a registered trademark of Maquet GmbH. Amsco® is a registered trademark of American Sterilizer Company. Berchtold® is a registered trademark of Berchtold Holding GmbH. CoFlex® is a registered trademark of Paradigm Spine, LLC. Cmax® is a registered trademark of Steris, Inc. DORO® is a registered trademark of Pro Med Instruments GmbH. 'Lectrolite® is a registered trademark of Aberdeen Road Co. Linvatec® is a registered trademark of Conmed Corporation. Maquet® is a registered trademark of Maquet GmbH. Mayfield® is a registered trademark of SM USA, Inc. Midmark® is a registered trademark of Midmark Corp. Operon® is a registered trademark of Berchtold Holding GmbH. Orthovision® is a registered trademark of the American Sterilizer Company. Ovation® is a registered trademark of Mizuho Orthopedic Systems, Inc. Schaerer® is a registered trademark of Schaerer Medical Management. Schaerer Mayfield® is a registered trademark of SCHAERER MEDICAL USA, INC. Champagne® is a registered trademark of Getinge USA. Siemens® is a registered trademark of Siemens Aktiengesellschaft. Skytron® is a registered trademark of Skytron LLC. Steris® is a registered trademark of Steris, Inc. SurgiGraphic® is a registered trademark of Steris Corp. Tyvek® is a registered trademark of E.I. du Pont de Nemours and Company. Velcro® is a registered trademark of Velcro Industries, BV.

Getinge™ is a trademark of Getinge International Inc. McConnell™ is a trademark of McConnell Orthopedic Manufacturing Company. Wilson™ is a trademark of Mizuho Orthopedic Systems, Inc. All other trademarks are property of their respective companies.

Products Are Not Made With Natural Rubber Latex

Product Serial Number Information

Allen Medical Systems' equipment (hard goods) is serialized and includes a serial number label. There are two types of labels (white or silver). Both contain six digits which may be preceded with a letter.



Type 1



Type 2

All Sterile and most non-sterile disposable products contain a lot number on the outside package/box.

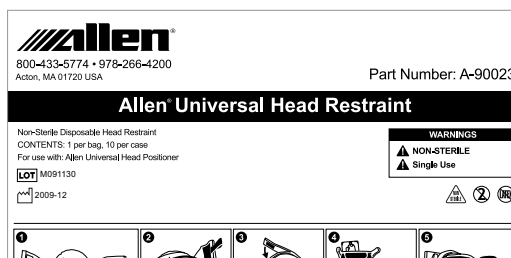

Surfaces and Pads have a letter/digit date code on the label that is attached to the underside of the pad.



In order for an item to be eligible for warranty, the serial or lot number must be on the product.

Want More? Visit Us Online

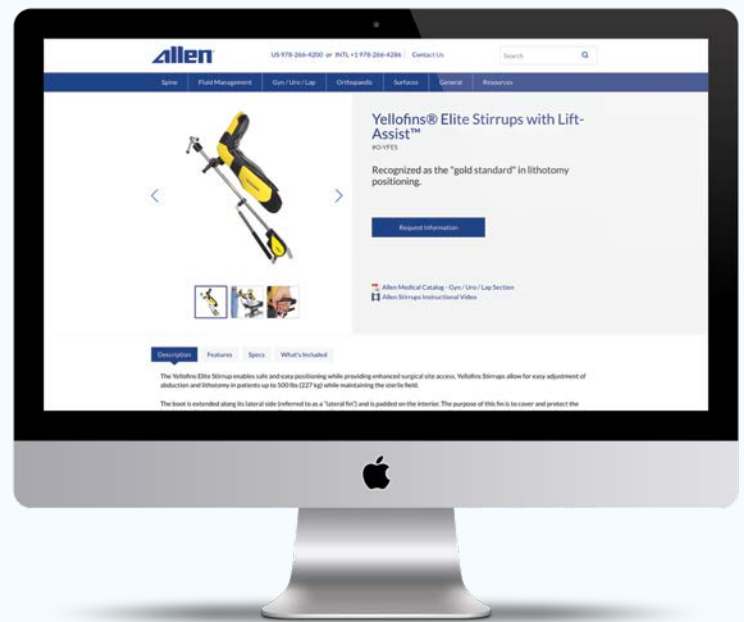

www.allenmedical.com

- Our entire product catalog is right at your fingertips with a simple navigation and search option.
- Access our PDF and Video library for even more information on our products.
- Quickly and easily request product information, quotes or live sales representative demonstrations.
- Responsive design makes for a great experience on desktop or mobile devices.

Follow Hill-Rom On Social Media

We want to hear from you.

Share a photo or post featuring our products then tag us and use #hillrom for a chance to be featured!



Search for "Hill-Rom"



@HillRomCorp



@HillRomCorp



Search for "Hill-Rom"

We Enhance Outcomes For Patients And Their Caregivers

Hill-Rom[®]

Enhancing outcomes for patients and their caregivers.[®]

Allen[®]

Innovative operative solutions for patient positioning.

Aspen
Surgical[®]

Enhancing patient and caregiver safety in the operating room.

Trumpf
Medical

Innovative solutions for enhanced safety and optimized workflow in the operating room.

WelchAllyn[®]

Smarter tools to assess, diagnose and treat patients with confidence.

Liko[®]

Protecting patients while mobilizing earlier and often.

Hill-Rom is a leading global medical technology company with more than 10,000 employees worldwide. We partner with health care providers in more than 100 countries, across all care settings, by focusing on patient care solutions that improve clinical and economic outcomes in five core areas: **Advancing Mobility, Wound Care and Prevention, Patient Monitoring and Diagnostics, Surgical Safety and Efficiency and Respiratory Health.** Our innovations ensure caregivers have the products they need to help diagnose, treat and protect their patients; speed up recoveries; and manage conditions. **Every day, around the world, we enhance outcomes for patients and their caregivers.** Learn more at hill-rom.com.

PATENTS / PATENT www.hill-rom.com/patents

The products in this catalog may be covered by one or more patents. See above Internet address.

Allen Medical Systems, Inc. is a Hill-Rom subsidiary. Hill-Rom & Allen are the proprietors of European, US, and other patents and pending patent applications.

Allen Medical Systems, Inc. reserves the right to make changes without notice in design, specifications and models. The only warranty Allen Medical Systems, Inc. makes is the express written warranty extended on the sale of its products.

Products may be comprised of new, refurbished and recycled materials. All refurbished and recycled materials meet our stringent new product specifications.

© 2018 Allen Medical Systems Inc. ALL RIGHTS RESERVED.
D-770176-B9

For further information about these products or a service, please contact your local Allen representative or visit our webpage:

United States

Toll-free (800) 433-5774
Phone (978) 266-4200
Fax (978) 263-8846
allenmedicalorders@hill-rom.com

Outside US

Sales +1 978 266 4256
Cust. Service +1 978 266 4286
Fax +1 978 266 4426
alleninternationalorders@hill-rom.com

Advance Table Tech Support (978) 266-4245

Please be prepared to provide the product serial number to the support person.

For International Technical Support, please contact your local Allen distributor.

Allen Medical, 100 Discovery Way, Acton, MA 01720

www.allenmedical.com

Enhancing outcomes for
patients and their caregivers:

Hill-Rom